



Experience the Sky



2022 COLLECTION

coelux.com



CoeLux 45 HC, Dental Clinic, Brenna & Levrini e Associati, Como (IT)

A modern living room with a skylight in the ceiling. The skylight is a large, square opening in the ceiling, framed by white trim, through which a clear blue sky is visible. A large, bright shadow is cast across the left wall from the skylight. In the foreground, there is a white coffee table with several stacks of magazines and a glass diffuser with reeds. Two leather armchairs, one black and one brown, are positioned around the coffee table. On the right wall, there is a large, dark, abstract painting.

WHY IS THE SKY BLUE?

PERCHÉ IL CIELO È BLU?

“Il cielo è blu
perché tu vuoi sapere
perché il cielo è blu.”

Jack Kerouac

indice

- 6 BENVENUTO / Vi diamo il benvenuto nella nostra idea di cielo
- 10 LA TECNOLOGIA / Può una tecnologia essere così vicina alla natura? (Sì!)
- 22 LASCIATI INSPIRARE / Il cielo nel tuo prossimo progetto di design
- 44 PRODOTTI / Contemplare il cielo

"The sky is blue
because you wanta know
why the sky is blue."

Jack Kerouac

index

- 6 WELCOME / We welcome you to our idea of sky
- 10 TECHNOLOGY / Can technology be so close to nature? (Yes!)
- 22 GET INSPIRED / The sky in your next design project
- 44 PRODUCTS / Look at the sky

Well, nice to
meet you



About us

Intro/ CoeLux is an Italian company based near Lake Como that patents, prototypes and produces high-tech systems capable of replicating the natural experience of the sun and sky typically found in outdoor settings. The human being recognises that the sky is an element of vital importance: wondering how to explore it and contemplating it in its variations, humans see the sky as an ancestral and global language. To imagine and appreciate an architectural space, thanks to the hyper-realistic technology developed by CoeLux, means to reinterpret the relationship between human beings and their surroundings.

Objects gleam in the exceptional light shining from the sky, casting sharp sky-blue shadows: especially in an underground environment, the effect is so powerful that it can radically change our perception of reality. It allows us to rediscover natural light in the real world in a totally new and surprising way.

Intro/ CoeLux è un'azienda italiana con sede nelle vicinanze del lago di Como che brevetta, prototipa e produce sistemi High-Tech in grado di replicare l'esperienza naturale del sole e del cielo tipica degli spazi outdoor. L'essere umano riconosce nel cielo un elemento di vitale importanza, contemplandolo nelle sue variazioni e chiedendosi come esplorarlo. Il cielo è un linguaggio ancestrale e globale. Immaginare e vivere lo spazio architettonico, attraverso la tecnologia iperrealistica sviluppata da CoeLux, significa reinterpretare il rapporto tra l'essere umano e il contesto in cui vive.

Gli oggetti risplendono nell'eccezionale luce proiettata dal cielo e attraverso nitide ombre azzurre: soprattutto in un ambiente sotterraneo, l'effetto è così potente che può cambiare radicalmente la nostra percezione della realtà, permettendoci di riscoprire la luce naturale nel mondo reale in un modo del tutto nuovo e sorprendente.

Words

We, CoeLux

Our history / The CoeLux project was initially developed as an academic spin-off at the University of Insubria in Como, drawing its inspiration from a theatrical performance with the aim of showing the audience the magic of atmospheric optical phenomena.

Today, CoeLux is an internationally acclaimed technology-driven company based on intensive innovative research through an interdisciplinary team in the fields of technological research, physics and design.

La nostra storia / Nato sulla scena teatrale con l'obiettivo di mostrare al grande pubblico la magia dei fenomeni ottici atmosferici, il progetto CoeLux si sviluppa dapprima come Spin-Off accademico all'interno dell'Università degli Studi Insubria di Como, Italia.

Ad oggi, CoeLux è un'azienda technology driven riconosciuta internazionalmente e che si basa su un'intensa attività di ricerca innovativa attraverso un team interdisciplinare nei campi della tecnologia, della fisica e del design.

Why us?

Indeed, we have won some of the most prestigious awards in lighting design but we are not comparable to any traditional lighting systems.

Why is CoeLux unique?

Because of the value that only CoeLux can offer and because of more than 150 IP rights between patents and patent applications filed worldwide.

(for more information, visit coelux.com)

Sì, abbiamo vinto alcuni dei premi più prestigiosi nel campo del lighting design,

ma non siamo paragonabili a nessun apparecchio di illuminazione tradizionale.

Perché CoeLux è un prodotto unico?

Per il valore che solo CoeLux può offrire e grazie agli oltre 150 diritti di proprietà intellettuale tra brevetti e domande di brevetto depositate in tutto il mondo.

(per maggiori informazioni vai su coelux.com)

Unique technology,
true sensations

Three core technologies

CoeLux is the first company faithfully to reproduce the full effect of the sky and sun in an artificial device.

- Custom-made, high-brightness LEDs that deliver the spectral quality, the luminance and the directionality that is necessary to produce a convincing simulation of the sun.
- Based on the psychological and physiological effects of human vision, CoeLux recreates the optical illusion of the sky and the sun located at an infinite distance from the observer through a sophisticated system of optics.
- A randomised dispersion of nanoparticles in a thin transparent material reproduces the same quality and the same amount of Rayleigh scattering that sun rays experience when crossing the atmosphere, which causes our sky to appear luminous and blue.

From day one, CoeLux has been making significant investments to create a unique value that only CoeLux can offer, with more than 150 IP rights between patents and patent applications filed worldwide, along the whole value chain of sun-sky simulating devices and related technologies.

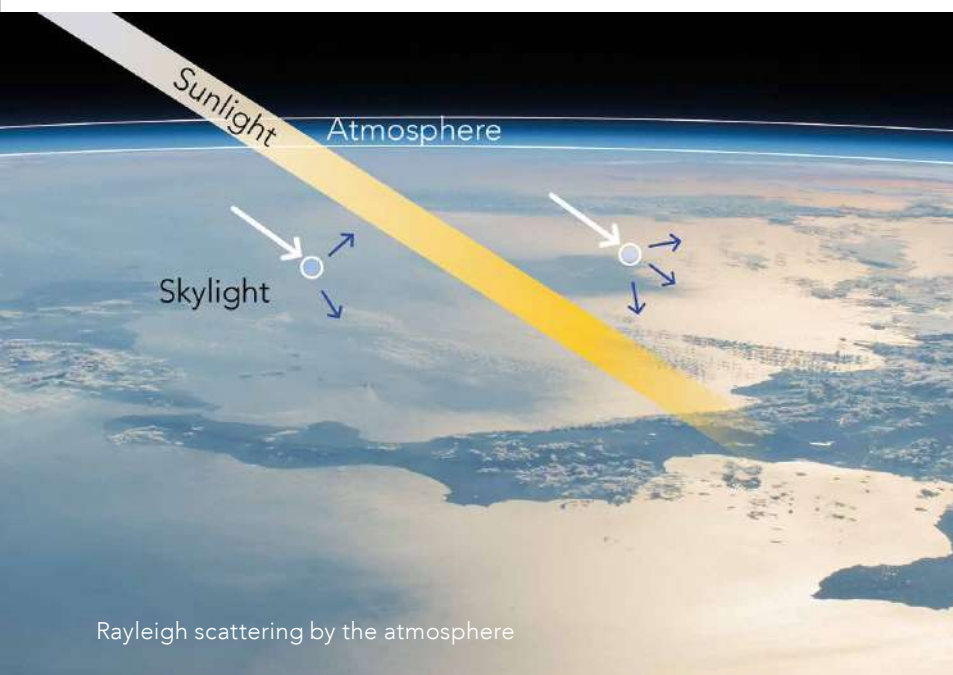

3 core Technologies / CoeLux è la prima azienda a riprodurre fedelmente l'effetto del cielo e del sole in un unico dispositivo artificiale.

- *LED ad alta luminosità in grado di conferire la qualità spettrale, la luminanza e la direzionalità necessarie per produrre una simulazione efficace del sole.*
- *Basandosi sugli effetti psicologici e fisiologici della visione umana, CoeLux ricrea l'illusione ottica del cielo e del sole situati ad una distanza infinita dall'osservatore, attraverso un sofisticato sistema di ottiche.*
- *Un sottile materiale trasparente in cui sono disperse le nanoparticelle riproduce l'effetto dei raggi solari diffusi dall'atmosfera terrestre (Scattering di Rayleigh), facendo apparire il cielo dei sistemi CoeLux luminoso e azzurro.*

Fin dal primo giorno, CoeLux ha significativamente investito per creare e tutelare un valore unico detenendo ad oggi 150 diritti di proprietà intellettuale tra Brevetti e Domande di Brevetto, depositate in tutto il mondo lungo l'intera catena del valore dei dispositivi di simulazione solare e delle relative tecnologie.

Visual appearance and infinite depth perception

According to the phenomenon of "Motion Parallax", a moving observer can see the sun following them; the perception of this slight movement of the sun makes the CoeLux systems all the more realistic.

Visual appearance e percezione infinita dello spazio / Secondo il fenomeno della "Motion Parallax", l'osservatore in movimento può notare il sole seguirlo; la percezione di questo lieve movimento del sole conferisce ulteriore realismo ai sistemi CoeLux.

The distance perceived as infinite by the CoeLux sun, contributes towards making the volume of the architectural space in which the system is installed perceptibly larger.

La distanza percepita come infinita del sole CoeLux, contribuisce a rendere percettibilmente più ampio il volume architettonico in cui viene installato il sistema.



CoeLux 45 HC, Uterque Shop (ES)



Ambient lighting through CoeLux

CoeLux® technology is capable of lighting up a setting with effects similar to those reproduced by natural light through an appropriate distribution of contrasts and colours. Daylight cannot be recreated without the combined reproduction of sunlight and the skylight.

Sunlight / the highly collimated, low CCT (yellow-orange) direct light component simulates sunlight, creating a defined, uniform beam of light, projecting parallel, sharp shadows of the lit objects.

Skylight / the high CCT (blue) diffused light component mimics the soft lighting effect of the sky inside the room with a blue light. The shapes and volumes of the objects, enhanced by the clear shadows cast by the sun, are thus tinged with azure blue.

< CoeLux Vs Traditional lighting (image below).



L'ambiente illuminato da CoeLux / La tecnologia CoeLux® è in grado di illuminare un ambiente con effetti simili a quelli riprodotti dalla luce naturale attraverso un'adeguata distribuzione di contrasti e colori.

La luce diurna, infatti, non può essere ricreata senza la riproduzione combinata di luce solare e del cielo.

Sunlight / la componente di luce diretta, altamente collimata e a bassa CCT (di colore giallo-arancione), simula la luce del sole creando un fascio luminoso definito e uniforme, proiettando ombre parallele e nitide degli oggetti illuminati.

Skylight / la componente di luce diffusa ad alta CCT (di colore blu), imita il morbido effetto di illuminazione del cielo all'interno dell'ambiente con una luce azzurra. Le forme e i volumi degli oggetti valorizzati dalle ombre nette proiettate dal sole, si tingono così di celeste azzurro.

Wood/ Textured surfaces/ Fabrics
The direct and diffused light of CoeLux highlights the textures of surfaces and objects.

Legno/ Superfici materiche/ Tessuti
La luce diretta e diffusa di CoeLux mette in evidenza le texture di superfici e oggetti.

CoeLux Smart Sky
recreates the atmosphere
closest to your emotions
and gives you all the
benefits of natural light

CoeLux Smart Sky ricrea l'atmosfera
più vicina alle vostre emozioni
regalandoti tutti i benefici della luce naturale

CoeLux Smart Sky Reproducing the whole day

CoeLux Smart Sky comprises innovative technology that introduces chromatic tunability in CoeLux products, reproducing the scenarios, colour and light intensity of the sky on a clear day, at sunrise, noon and sunset. Natural light is responsible for controlling a range of human functions: lighting improves perceived comfort levels, as well as psychological and physiological well-being. By introducing the Smart Sky technology into CoeLux products, it is possible to simulate the changes in natural light over the course of the day, enhancing the value of CoeLux Classic products.

The perception of recreated sunlight maintains visual balance and improves people's quality of life. The benefits include increased melatonin production, reduced stress, as well as improved attention and concentration.

CoeLux Smart Sky is available for CoeLux HT25, CoeLux HT25 Mini and CoeLux Sky Line products.

CoeLux Smart Sky è una tecnologia innovativa che introduce la sintonizzazione cromatica nei prodotti CoeLux, riproducendo gli scenari, colore e intensità luminosa, del cielo durante una giornata limpida, all'alba, a mezzogiorno e al tramonto. La luce naturale è responsabile del controllo di una serie di funzioni umane: l'illuminazione migliora i livelli di comfort percepito, così come il benessere psicologico e fisiologico. Introducendo la tecnologia Smart Sky nei prodotti CoeLux, è possibile simulare i cambiamenti della luce naturale nel corso della giornata, aumentando il valore dei prodotti Classic CoeLux.

La percezione della luce solare ricreata mantiene l'equilibrio visivo e migliora la qualità della vita delle persone. I benefici includono una maggiore produzione di melatonina, una riduzione dello stress, così come una migliore attenzione e concentrazione.

CoeLux Smart Sky è disponibile per i prodotti CoeLux HT25, CoeLux HT25 Mini e CoeLux Sky Line.



Sunrise/ Alba



Noon/ Mezzogiorno



Sunset/ Tramonto

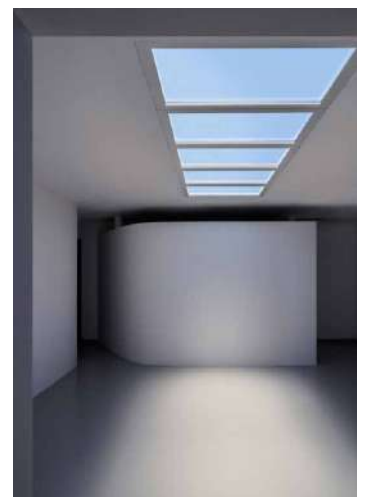

Late evening/ Tarda serata

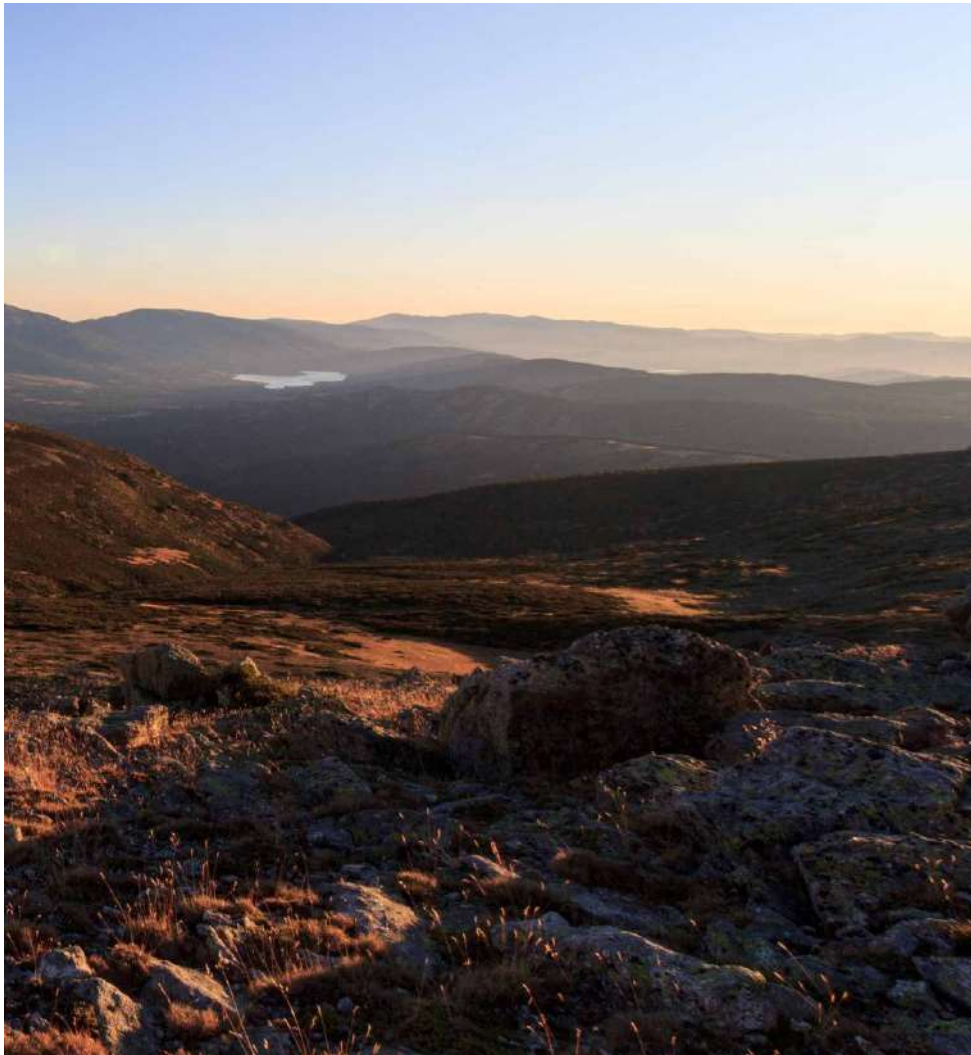

Interconnected, in nature as in CoeLux Smart Sky products, the sky and sun change colour and intensity distinctly with the passing of time, mimicking the relationship between sunlight and the atmosphere and reproducing the Rayleigh Scattering phenomenon.

CoeLux Smart Sky is based on an electro-optical effect. The Smart Sky diffusive sky-like panel scatters the light in the same way the atmosphere scatters the sun rays, reproducing the different lighting scenarios of the day (sunrise – noon – sunset) by applying voltage to the panel itself.

Interconnessi, in natura come nei prodotti CoeLux Smart Sky, il cielo e il sole cambiano colore e intensità distintamente con il passare del tempo imitando la relazione tra la luce solare e l'atmosfera e riproducendo il fenomeno di Rayleigh Scattering.

CoeLux Smart Sky si basa su un effetto elettro-ottico. Il pannello diffusivo Smart Sky, simile al cielo, diffonde la luce nello stesso modo in cui l'atmosfera diffonde i raggi solari riproducendo i diversi scenari di illuminazione del giorno (alba - mezzogiorno - tramonto) e applicando una tensione al pannello stesso.

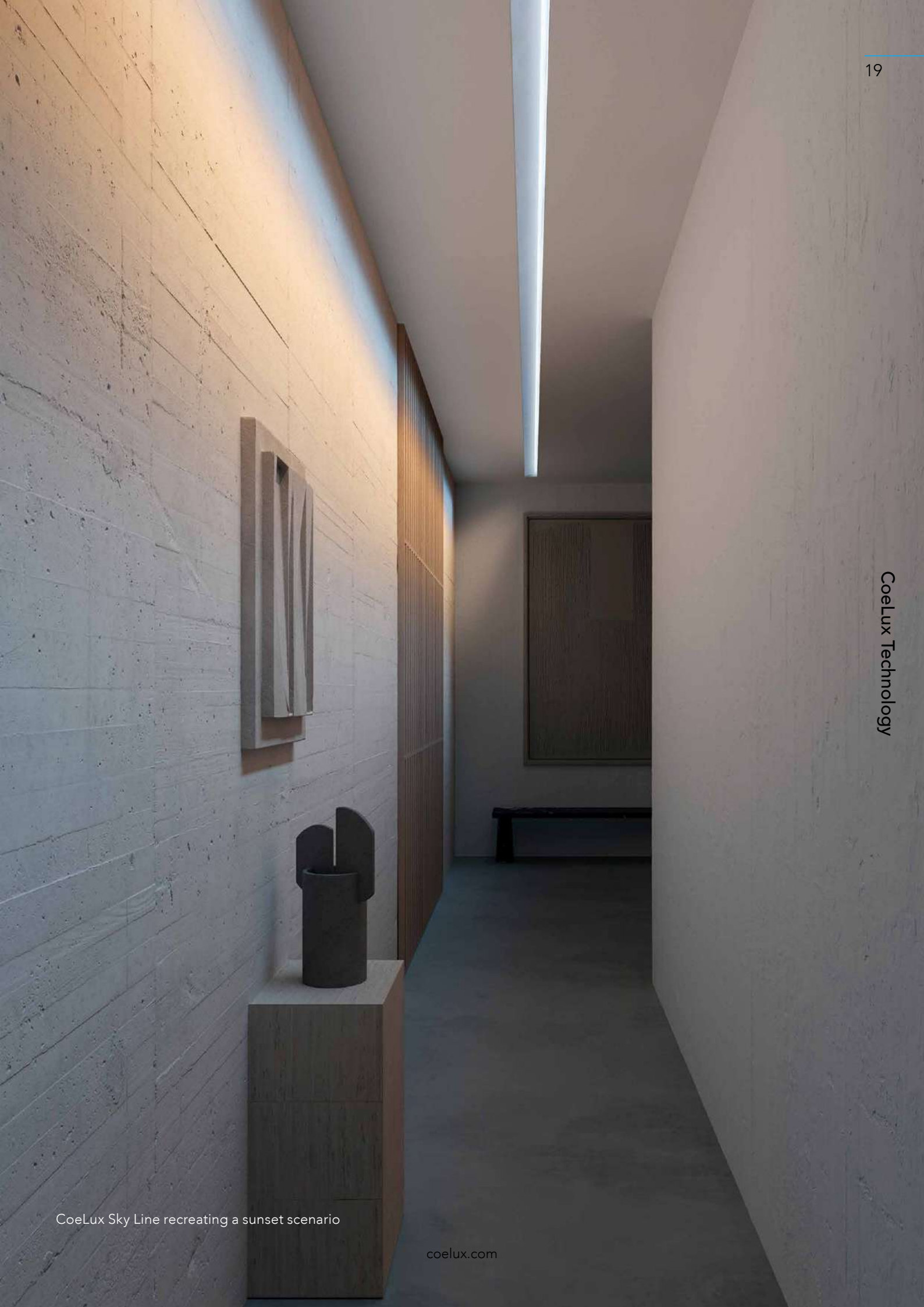

CoeLux Sky Line recreating a sunset scenario



Coelux HT25 Mini Semi recessed recreating a sunset scenario



Noon



Sunset



Meditation



Wake up



Focus



Aperitivo

SET THE ATMOSPHERE

Creare l'atmosfera

CoeLux products and Smart Sky can be operated through a DALI, 0-10V or Casambi control system, working via Bluetooth, App or keypad. A scene can be set in sync with the course of the day for one or more CoeLux devices, or several scenes can be integrated according to the environmental requirements.

I prodotti CoeLux e Smart Sky possono essere gestiti attraverso un sistema di controllo DALI, 0-10V o Casambi, via Bluetooth, app o tastierino.

Una scena può essere impostata in sincronia con il corso vostra giornata per uno o più dispositivi CoeLux, o più scene possono essere integrate a seconda delle esigenze dello spazio.

Proud to show you





Bellissimo

Let yourself be inspired by the CoeLux projects, scenic creations from around the world.

To know find out more about our projects, please visit:
www.coelux.com/en/projects/index

Lasciati ispirare dai progetti CoeLux, sceniche installazioni da tutto il mondo.

Per saperne di più, visita la pagina www.coelux.com/en/projects/index



CoeLux LS Array, Neonatology department at Mangiagalli Hospital, Milan (IT)

The appropriate positioning of CoeLux systems enhances the windows present in the space, striking a balance between real and artificial

L'accurato posizionamento dei sistemi CoeLux nello spazio, potenzia le finestre presenti in equilibrio tra reale e artificiale



THE LIVELINESS OF THE SKY

La vitalità del cielo

10 CoeLux systems have been installed at the Neonatal Intensive Care Department of the Mangiagalli Clinic in Milan (Italy). Premature newborns are thus accompanied towards the discovery of natural light, essential for a healthy and balanced psycho-physiological growth of the human being and an essential condition in the healing process.

Presso il reparto di Terapia Intensiva Neonatale della clinica Mangiagalli di Milano (IT) sono stati installati 10 sistemi CoeLux. I neonati prematuri vengono accompagnati così verso la scoperta della luce naturale, fondamentale per una sana ed equilibrata crescita psico-fisiologica dell'essere umano e condizione essenziale nel processo di guarigione.

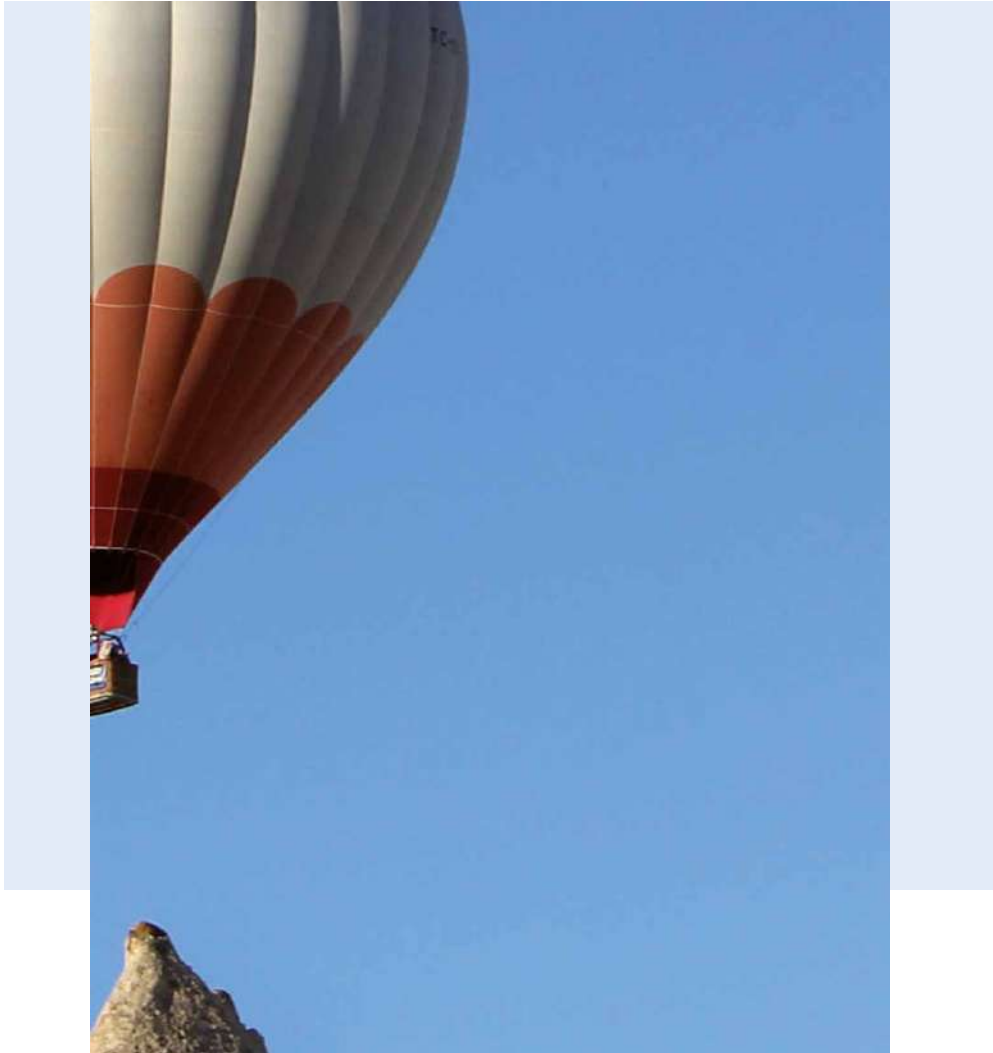

CoeLux technology enables the physical reconstruction of natural light, giving people the opportunity to experience the sun and the sky anywhere

La tecnologia CoeLux permette la ricostruzione fisica della luce naturale, dando alle persone l'opportunità di sperimentare l'esperienza del cielo e del sole ovunque





A NEW APPROACH TO CARING ABOUT ARCHITECTURAL SPACES

Un nuovo approccio di cura degli spazi architettonici

Within the lighting design of the Department of Oncological Radiology of the La Tour Hospital in Geneva (CH), several high-tech CoeLux systems have been installed to create the perception of natural and comfortable lighting throughout the department, even though it is on the third level underground. The light has an effect on the visual, biological and emotional functions, and the patients and healthcare staff in the department are outstanding proof of this.

All'interno del progetto illuminotecnico del dipartimento di Radiologia Oncologica dell'Ospedale La Tour di Ginevra (CH), sono stati inseriti diversi sistemi high-tech CoeLux per creare in tutto il reparto la percezione di un'illuminazione naturale e confortevole, nonostante esso si trovi al piano -3. La luce ha effetto sulle funzioni visive, biologiche ed emotive ed i pazienti e il personale sanitario del reparto ne sono una straordinaria testimonianza.

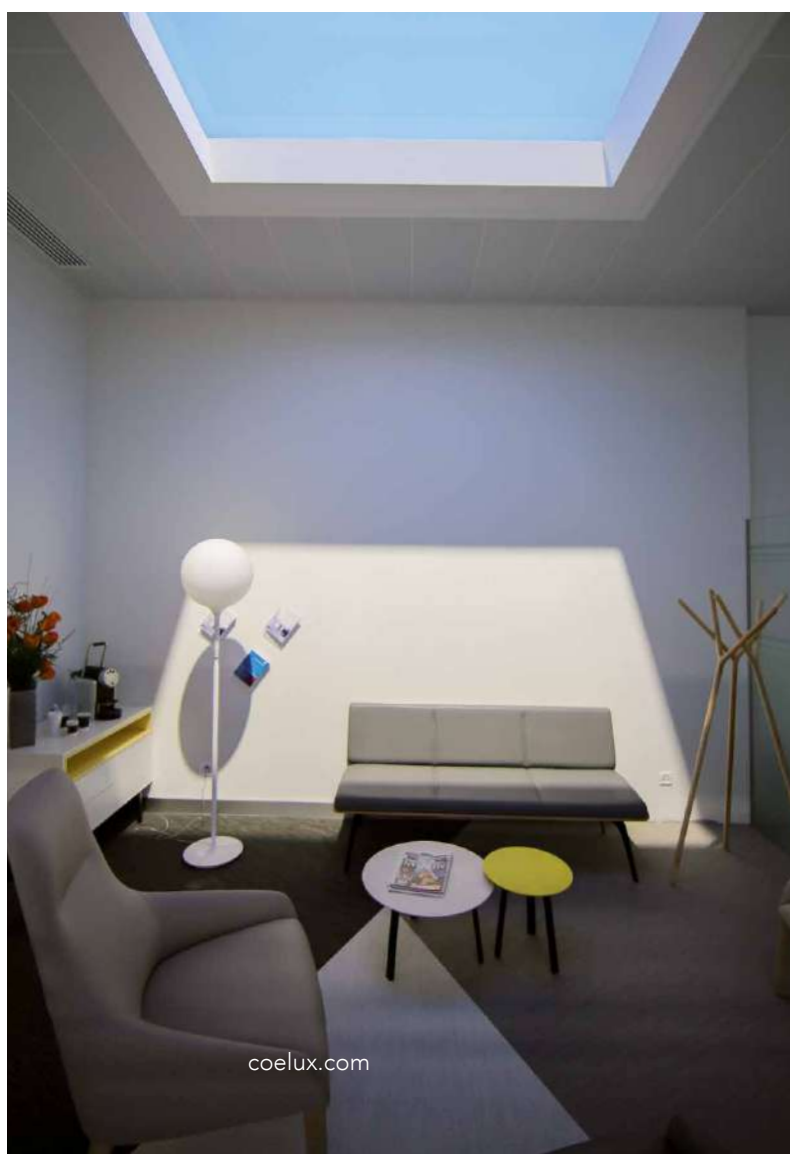



Palazzo Clerici, Milan (IT)

The artist depicts light even in
the smallest fold, enhancing
volume and colour.

L'artista ritrae la luce
anche nel più piccolo
drappeggio, esaltandone
volumi e colori.



Get inspired





EXPERIENTIAL RETAIL

Acquisti esperienziali

The CoeLux sun appears on the lower floor of the SMEG showroom in Brera, one of Milan's Design districts, illuminating its products with natural light where the colours, materials and textures best express their essence. The exhibition space opens up towards the sky and the outside, encouraging the sale by making the decision-making and purchasing processes more enjoyable.

Il sole di CoeLux compare al piano inferiore dello showroom SMEG in zona Brera / distretto del Design (Milano), illuminando i suoi prodotti con la luce naturale. I colori, i materiali e le texture esprimono al meglio la loro essenza. Lo spazio espositivo si apre verso il cielo e verso l'esterno rendendo più piacevole e favorevole il processo di decision-making e l'acquisto.





COSMIC SPACE

Spazio cosmico

In any architectural project, the wise play of light enhances our perception of space and its volumes. CoeLux is the solution for windowless rooms such as bathrooms, elevator landings, underground rooms, etc. and it greatly improves the quality of the living space.

In qualunque progetto architettonico, il gioco sapiente delle luci valorizza la nostra percezione dello spazio e dei suoi volumi. CoeLux è la soluzione laddove gli ambienti sono vani ciechi senza finestre come bagni, sbarchi ascensori, seminterrati, etc. migliorando notevolmente la qualità dello spazio abitativo.

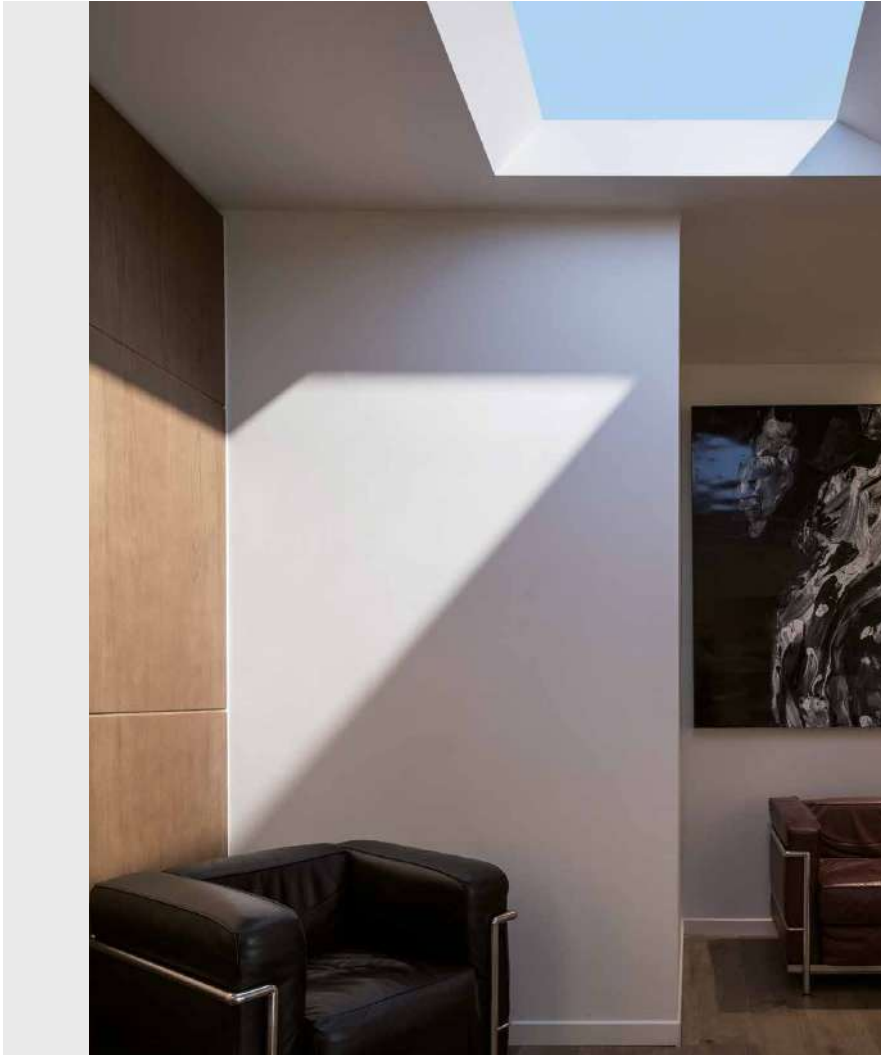

Ambient lighting
generated by CoeLux amid
lights and shadows

*Ambiente illuminato da
CoeLux tra luci ed ombre*

Get inspired





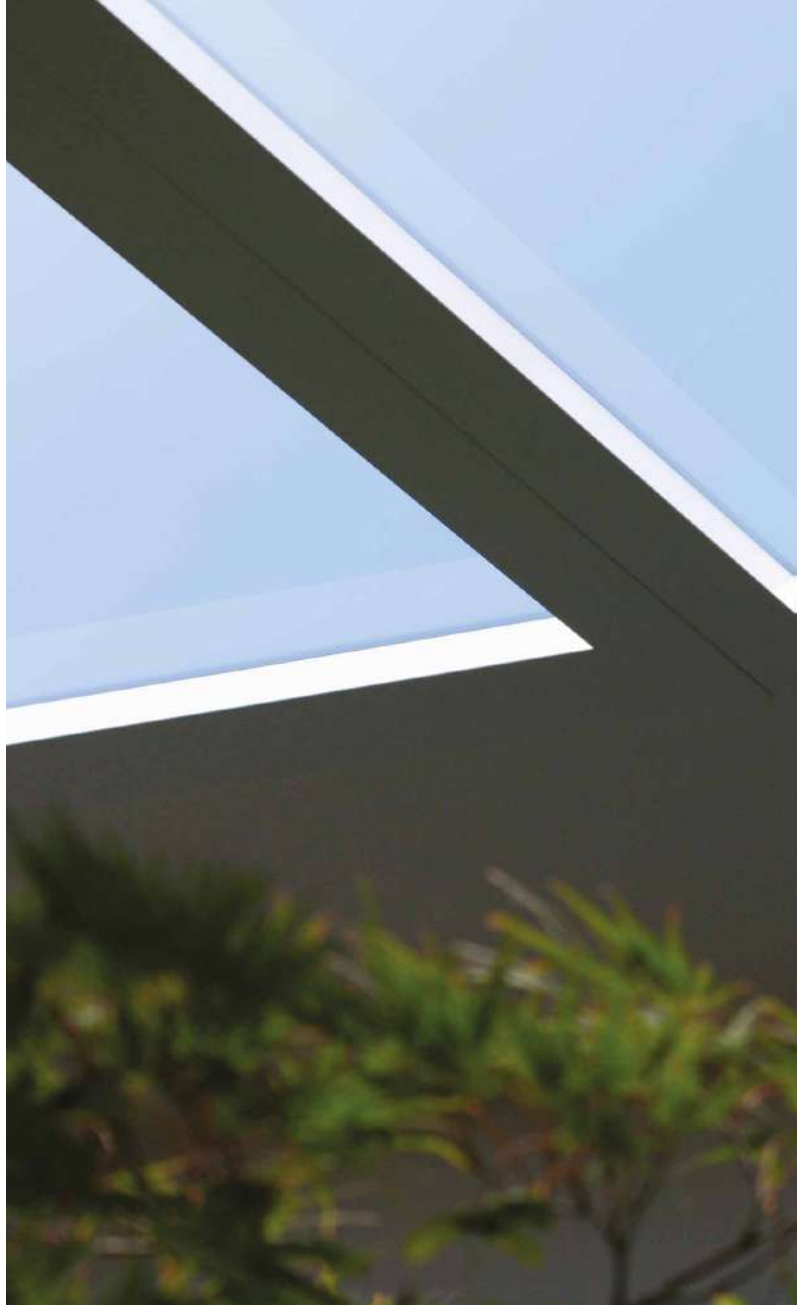

WORKPLACES AND WELL-BEING

Luoghi di lavoro e benessere

Studies carried out in collaboration with international research institutes and universities have highlighted the positive effects of CoeLux on people in the workplace, such as increased melatonin production, reduced stress and improved work readiness. The offices, the transit areas and the meeting rooms at our Lomazzo headquarters all benefit from the presence of CoeLux's sky and sun in the workspace.

Gli studi effettuati in collaborazione con alcuni istituti di ricerca internazionale e università, hanno evidenziato gli effetti positivi di CoeLux sulle persone all'interno dei luoghi di lavoro. Nel dettaglio: l'aumento di produzione della melatonina, la riduzione dello stress ed una maggiore prontezza sul lavoro. Gli uffici, le zone di transito e le sale riunione della nostra sede di Lomazzo godono della presenza del cielo e del sole di CoeLux all'interno degli spazi.





PSYCHOPHYSICAL WELL-BEING

Benessere psicofisico

Standard Dose launches a wellness experience in New York City, in the iconic NoMad neighborhood, opening up a three-story space dedicated to relaxation and body and mind care. CoeLux, installed in a space dedicated to meditation, contributes to reducing stress and increasing the sense of well-being.

Standard Dose lancia a New York City un'esperienza di benessere, nell'iconico quartiere NoMad, aprendo uno spazio a tre piani, dedito al relax e alla cura del corpo e della mente. CoeLux, installato in uno spazio dedicato alla meditazione, contribuisce alla riduzione dello stress e all'aumento del senso di benessere.



CoeLux 45 HC, SPIN, SPazio INnovazione of Ars et Inventio
Milan (IT)

"One day, while admiring Magritte's painting "Empire des Lumieres", I had an amazing artistic realization when I understood the fantastic paradox the painting depicts: a house, dimly lit by a street lamp in the dark of night, and behind it, a bright daytime blue sky, streaked with white clouds. Two very realistic, seemingly trivial scenes, which together make a masterpiece.

So I learned that art, even if surrealistic, is a 'window onto the real world': an opening, through which we can look and discover, amazed like children, the reality that exists. For me, CoeLux is a surreal window onto the real world."

CoeLux founder and CEO, Prof. Paolo Di Trapani



Get inspired

“Un giorno, ammirando il quadro di Magritte “Empire des Lumieres”, ho avuto una sorprendente realizzazione artistica quando ho capito il fantastico paradosso che il quadro raffigura: una casa, scarsamente illuminata da un lampione nel buio della notte, e dietro di essa un cielo azzurro di giorno, striato di nuvole bianche. Due scene molto realistiche e apparentemente banali, che insieme formano un capolavoro. Così ho imparato che l’arte, anche se surreale, è una “finestra sul mondo reale”: un’apertura, attraverso la quale possiamo guardare e scoprire, stupiti come bambini, la realtà che esiste. Per me, CoeLux è una finestra surreale sul mondo reale”.

CoeLux founder and CEO, Prof. Paolo Di Trapani

CoeLux Systems

OUR PRODUCTS FAMILIES

CoeLux High Tech

"Any sufficiently advanced technology is indistinguishable from magic" say's Arthur C. Clarke, author of Space Odyssey. CoeLux HT is pure magic, enclosing within a few centimetres a high-end technology that can be integrated even in small heights, providing the same magic of the sky and the sun that we find in nature.

"Ogni tecnologia sufficientemente avanzata è indistinguibile dalla magia", Arthur C. Clarke, autore di Odissea nello Spazio. CoeLux HT è pura magia, racchiudendo in pochi centimetri una tecnologia di alta gamma, incassabile anche in altezze ridotte. La stessa magia del cielo e del sole che ritroviamo in natura.

CoeLux Sky Line

The essence of natural light. CoeLux Sky Line can be installed in one or more linear units, to balance the amount of natural light in the room, or together with traditional CoeLux Skylight products, increasing the CoeLux product experience.

L'essenza della luce naturale. CoeLux Sky Line può essere installato in una o più unità lineari, per bilanciare la mancanza di luce naturale nella stanza, oppure insieme ai tradizionali prodotti Skylight CoeLux, potenziando ulteriormente l'esperienza dei prodotti CoeLux.

CoeLux Long Sky

An elongated window, available in three versions and versatile in its installation possibilities.

Una finestra allungata, disponibile in tre varianti e versatile nelle possibilità di installazione.

CoeLux High End

What would day be without night? Large windows enclose a blue sky of infinite depth and a clear sun, which can create soft spots of warm light. For some of the products, the Sun and Moon versions are available as required for a spectacular nocturnal scenario.

Cosa sarebbe il giorno senza la notte? Grandi finestre ospitano un cielo azzurro dalla profondità infinita e un sole nitido, in grado di creare morbidi spot di luce calda. A piacere, è disponibile per alcuni prodotti la versione Sole e Luna per uno scenografico scenario notturno.

OUR PRODUCTS

	pg
CoeLux HT25	48
CoeLux HT25 Mini	54

	pg
CoeLux Sky Line	62

	pg
CoeLux LS Ice	68
CoeLux LS Matte	72
CoeLux LS Array	76

	pg
CoeLux 45 HC	84
CoeLux 45 LC	92
CoeLux 45 Square	100

CoeLux HT

High Tech

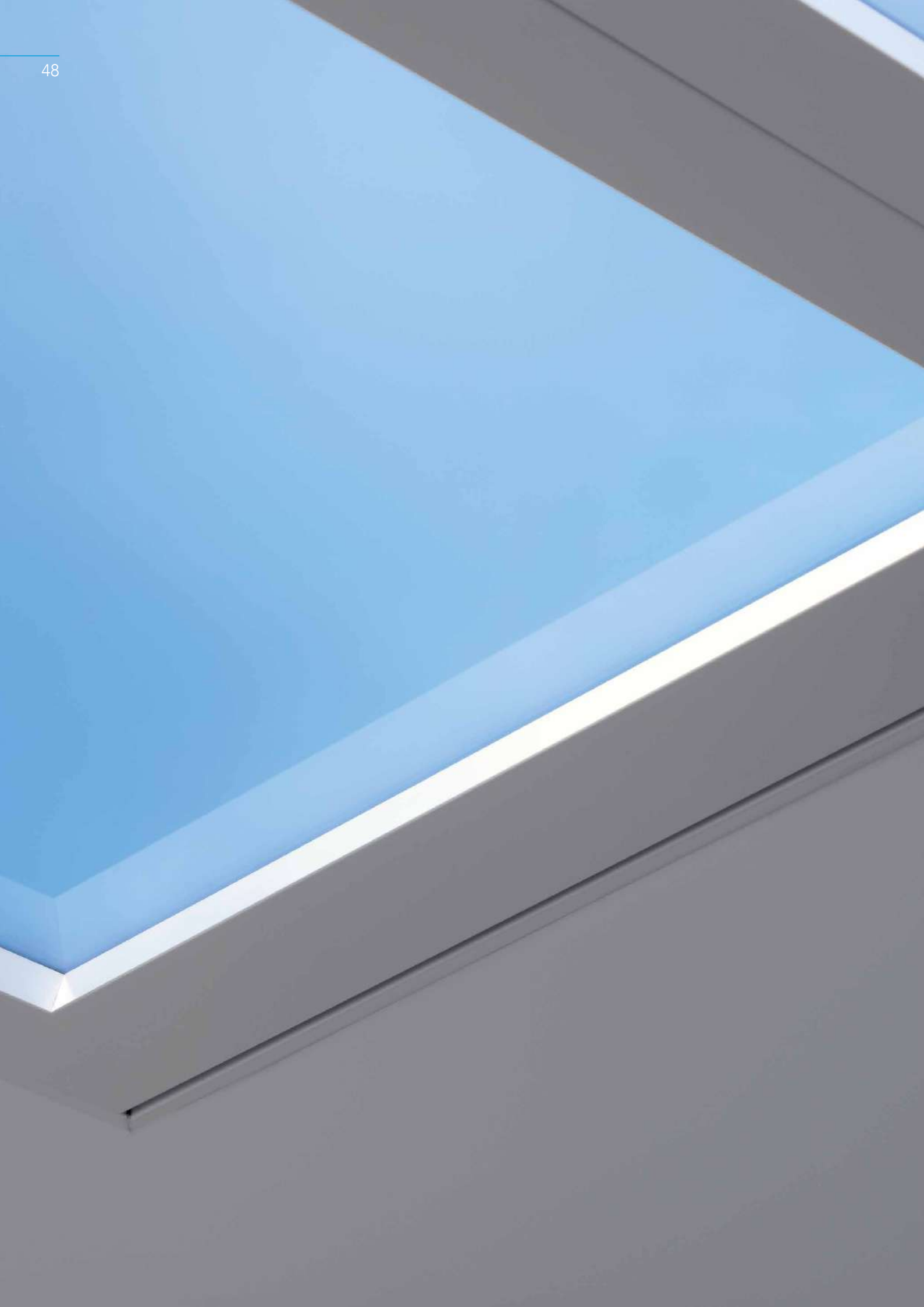

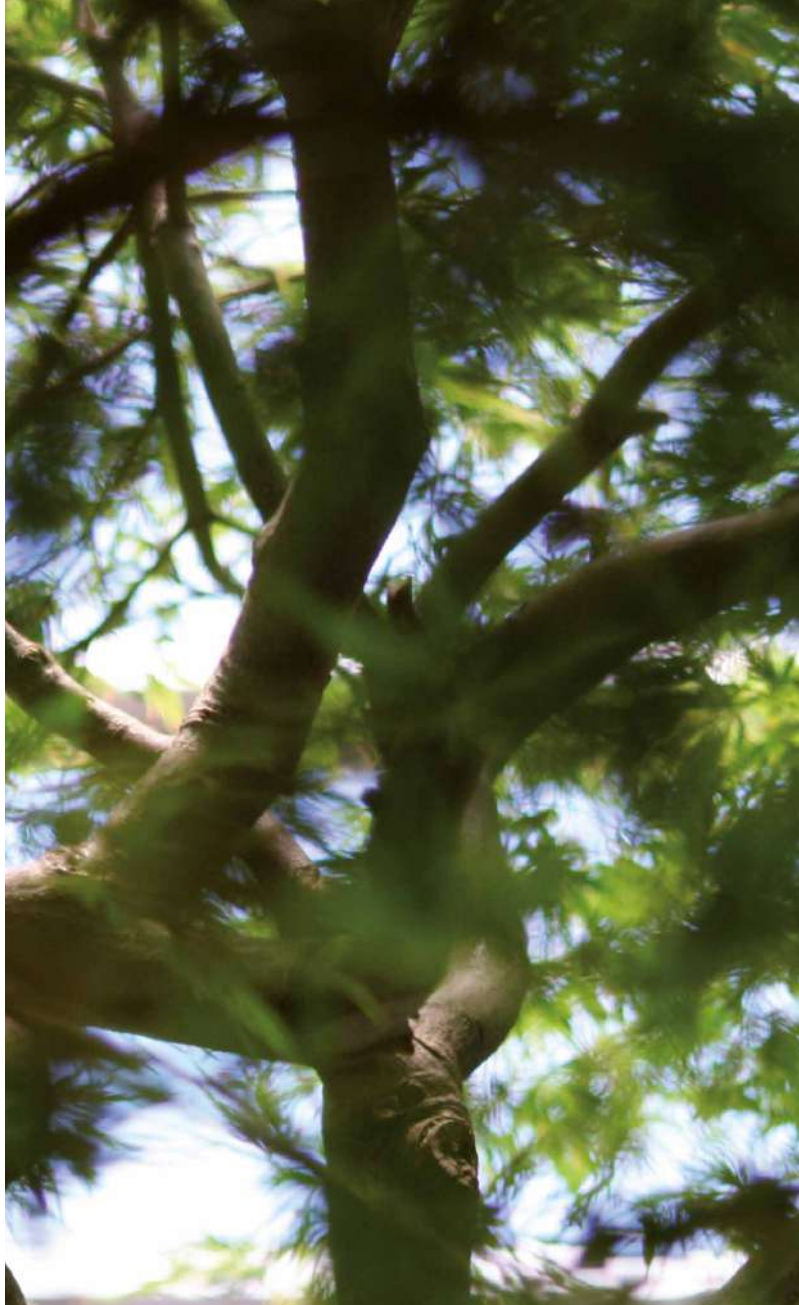

CoeLux HT25

High Tech Flat







Featuring a zenithal beam of light and a versatile design, CoeLux HT25 encloses a 25 cm thick rectangular window with a clear and serene sky. Ideal for creating semi-continuous windows, it can give the perception of large portions of sky.

Caratterizzato da un fascio di luce zenitale e dal design versatile, CoeLux HT25 racchiude in 25 cm di spessore, una finestra rettangolare dal cielo terso e sereno. Ideale per la creazione di finestre semi-continue, regala la percezione di grandi porzioni di cielo.

CoeLux HT25

TECHNICAL INFORMATION:

SKYLIGHT SIZE Dimensione dello skylight	520 x 1070 mm 22.4 x 42.1"
WEIGHT Peso	50 kg 110 lb
NECESSARY SPACE FOR INSTALLATION Dimensioni minime necessarie	1200 x 600 x 250 mm 47.2 x 23.6 x 9.8"

	 zenith  0.4-100%  Classic	 zenith  0.4-100%  Smart Sky
VERSIONS AVAILABLE Varianti disponibili	Classic	Smart Sky
POWER INPUT Power input	2 channels at 24 V DC	2 channels at 24 V DC
POWER CONSUMPTION Consumo energetico	170 W (Max) - 170 W (Typical)	210 W (Max) - 210 W (Typical)
TOTAL LIGHT OUTPUT Emissione luminosa	5900 lm	5300 lm (noon) - 4500 lm (sunset)
FRAME Cornice	The frame can be ceiling mounted or recessed flushed mounted La cornice può essere montata a filo del contro-soffitto o leggermente sporgente	
ORDER CODE CERTIFICATION Codice di ordinazione Certificazione	Remote PSUs - on request HT25-3L-DAL-01 CE, CB, UL, PSE HT25-3L-010-01 CE, CB, UL ongoing	Remote PSUs - on request HT25-SS-DAL-01 CE, CB, UL ongoing HT25-SS-010-01 CE, CB, UL ongoing

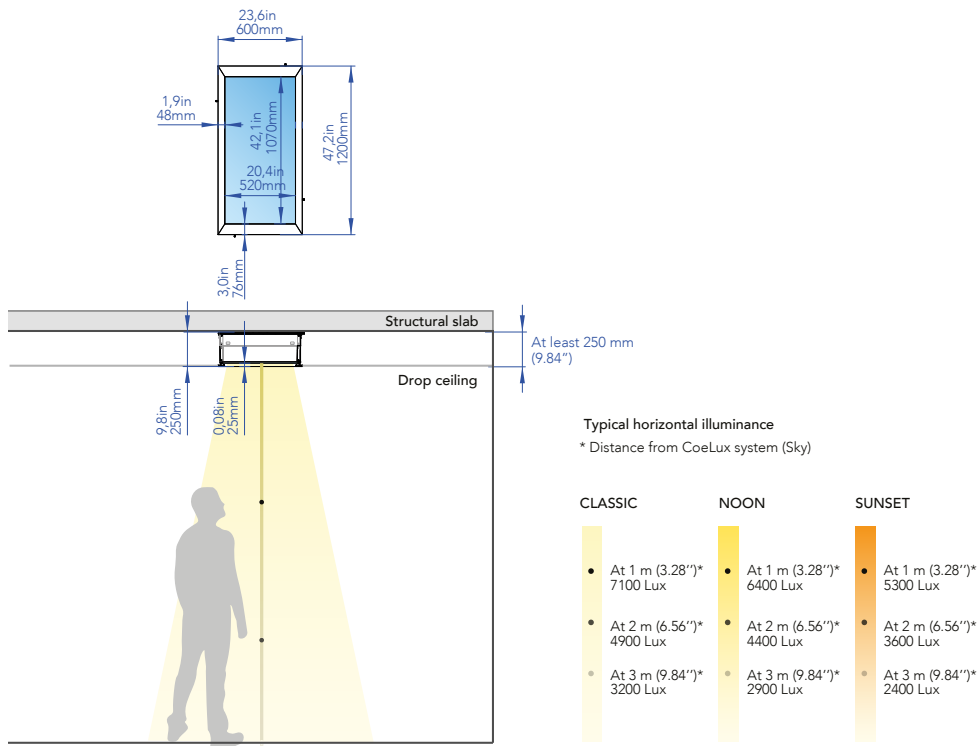

MOUNTING OPTIONS:

Ceiling mounted
Cornice in rilievo

Recessed flushed
Cornice a filo

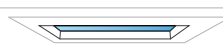

Novelties
2022

The beauty of the day, in its changing essence, guides us with colours and intensity effects. In addition to the Classic model, CoeLux HT25 is available in the Smart Sky version, where you can benefit from natural light that can be adapted to your needs, or program sets and dynamics that follow the course of the day.

La bellezza del giorno, nella sua mutevole essenza, ci accompagna con cromatismi e giochi di intensità. Oltre alla versione Classic, CoeLux HT25 è disponibile nella versione Smart Sky, nella quale poter beneficiare di una luce naturale adattabile alle proprie esigenze, o programmare set e dinamiche che seguono lo scorrere della giornata.





By moving around the area below the system, the viewer will be able to see a large portion of sky. By standing underneath the system, the sun will appear slightly diffused and not too dazzling.

Muovendosi attorno all'area sottostante al sistema, l'osservatore sarà in grado di vedere un'ampia porzione di cielo; avvicinandosi ed entrando nel fascio di luce emesso comparirà il sole, leggermente diffuso e poco abbagliante.





CoeLux HT25 Mini
Recessed Trim with
different light intensities
and chromaticisms.

CoeLux HT25 Mini
Recessed Trim a diverse
intensità luminose e
cromatismi.



CoeLux HT25 Mini

CoeLux HT25 Mini

Postcards from the sky

CoeLux HT25 Mini is a small size solution that brings the sky and the sun into indoor settings with no natural light and is perfect for small to medium-sized domestic and contract spaces. A concentrated blue sky of infinite depth emits a comfortable diffused light and a zenithal light beam, recreating a natural accent light.

CoeLux HT25 Mini è la soluzione in formato small size in grado di portare il cielo e il sole in spazi indoor privi di luce naturale, ed è ideale per ambienti domestici e contract di piccole e medie dimensioni. Un concentrato di cielo azzurro dalla profondità infinita emette una confortevole luce diffusa e un fascio di luce zenitale, in grado di ricreare una naturale luce d'accento.







CoeLux HT25 Mini

TECHNICAL INFORMATION:

SKYLIGHT SIZE Dimensione dello skylight	492 x 233 mm 19.3 x 9.1"
WEIGHT Peso	17.5 kg 38.5 lb
NECESSARY SPACE FOR INSTALLATION* Dimensioni minime necessarie	630 x 371 x h250mm 24.8 x 14.6 x h9.8"

*dimensions may differ slightly depending on the versions

*le dimensioni possono differire leggermente a seconda delle varianti

VERSIONS AVAILABLE Varianti disponibili	 zenith  0.4-100%  Classic		 zenith  0.4-100%  Smart Sky	
	Classic		Smart Sky	
POWER INPUT Power input	1 channel at 24 V DC		1 channels at 24 V DC	
POWER CONSUMPTION Consumo energetico	42.5 W (Max) - 42.5 W (Typical)		50 W (Max) - 46 W (Typical)	
TOTAL LIGHT OUTPUT Emissione luminosa	1600 lm		1400 lm (noon) - 1200 lm (sunset)	
FRAME AND MOUNTING OPTIONS: Cornice e montaggio:	The system can be surface mounted, semi-recessed, recessed (trim or trimless) Il sistema può essere montato a soffitto/parete, sporgente dal contro-soffitto, o ad incasso(trim o trimless)			
MOUNTING OPTIONS Opzioni di montaggio	Recessed Trimless / Remote PSU - on request		Recessed Trimless / Remote PSU - on request	
ORDER CODE CERTIFICATION Codice di ordinazione Certificazione	HT25MINI-3L-DAL-A-01 CE, CB, UL ongoing HT25MINI-3L-010-A-01 CE, CB, UL ongoing		HT25MINI-SS-DAL-A-01 CE, CB, UL ongoing HT25MINI-SS-010-A-01 CE, CB, UL ongoing	
	Recessed trim / Remote PSU - on request		Recessed trim / Remote PSU - on request	
	HT25MINI-3L-DAL-B-01 CE, CB, UL ongoing HT25MINI-3L-010-B-01 CE, CB, UL ongoing		HT25MINI-SS-DAL-B-01 CE, CB, UL ongoing HT25MINI-SS-010-B-01 CE, CB, UL ongoing	
	Semi recessed / Remote PSU - on request		Semi recessed / Remote PSU - on request	
	HT25MINI-3L-DAL-C-01 CE, CB, UL ongoing HT25MINI-3L-010-C-01 CE, CB, UL ongoing		HT25MINI-SS-DAL-C-01 CE, CB, UL ongoing HT25MINI-SS-010-C-01 CE, CB, UL ongoing	
	Surface mounted / On board PSU - included		Surface mounted / On board PSU - included	
	HT25MINI-3L-DAL-D-01 CE, CB, UL ongoing HT25MINI-3L-010-D-01 CE, CB, UL ongoing		HT25MINI-SS-DAL-D-01 CE, CB, UL ongoing HT25MINI-SS-010-D-01 CE, CB, UL ongoing	

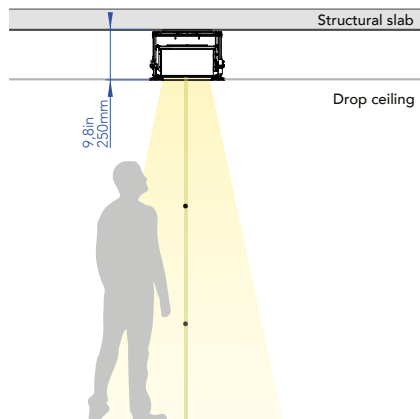
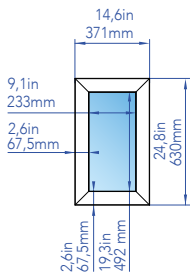

Typical horizontal illuminance
* Distance from CoeLux system (Sky)

CLASSIC	SMART SKY NOON	SMART SKY SUNSET
<ul style="list-style-type: none"> At 1 m (3.28")* 3600 Lux At 2 m (6.56")* 2000 Lux At 3 m (9.84")* 800 Lux 	<ul style="list-style-type: none"> At 1 m (3.28")* 3200 Lux At 2 m (6.56")* 1800 Lux At 3 m (9.84")* 700 Lux 	<ul style="list-style-type: none"> At 1 m (3.28")* 2700 Lux At 2 m (6.56")* 1500 Lux At 3 m (9.84")* 600 Lux

MOUNTING OPTIONS:

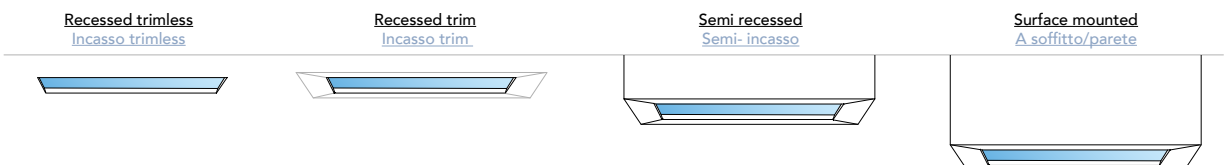

CoeLux HT25 Mini





CoeLux HT25 Mini Recessed Trim, wall installation

CoeLux HT25 Mini

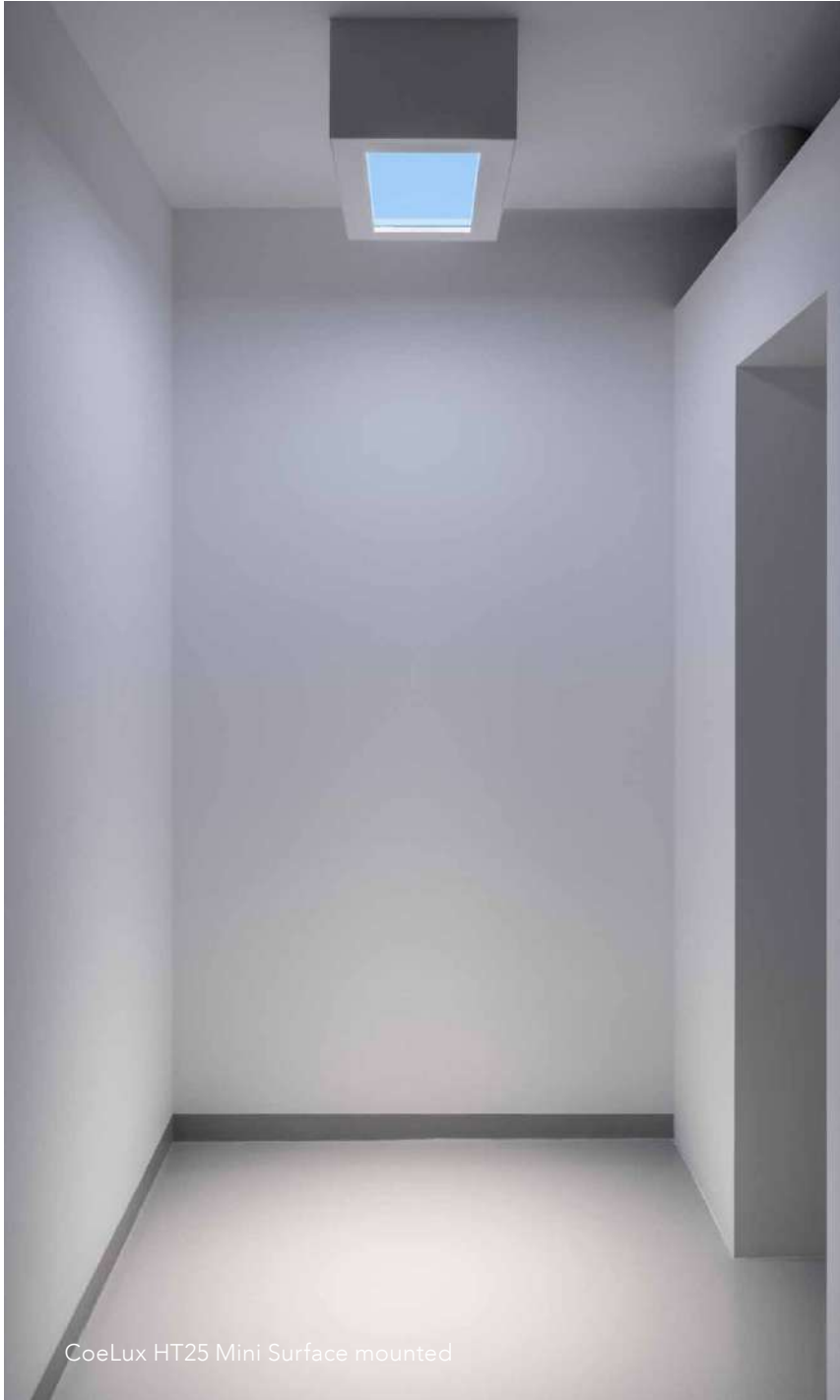

CoeLux HT25 Mini Surface mounted

CoeLux Sky Line

CoeLux Products



CoeLux Sky Line with
different light intensities
and chromaticisms.

CoeLux Sky Line a diverse
intensità luminose e
cromaticismi.



CoeLux Sky Line

CoeLux Sky Line

A visible reminder of the invisible sky







CoeLux Sky Line diffuses the original CoeLux natural lighting into the room through a minimalist, linear wall washer product. On the wall, an intense yellow directional light spot will evoke the sun, in harmonious contrast with the diffused blue light that characterises the CoeLux sky.

CoeLux Sky Line diffonde nella stanza l'originale illuminazione naturale CoeLux attraverso un prodotto wall washer, minimal e lineare. A parete, un intenso spot di luce direzionale gialla evoccherà il sole, in armonico contrasto con la luce diffusa dai toni azzurri che caratterizza il cielo CoeLux.

CoeLux Sky Line

TECHNICAL INFORMATION:

SKYLIGHT SIZE Dimensione dello skylight	1178x30 mm 46.4 x 1.2"
WEIGHT Peso	6 kg 13.2 lb
NECESSARY SPACE FOR INSTALLATION* Dimensioni minime necessarie	1256 x 186 x h120 mm 49.4 x 7.3 x h4.7"

VERSIONS AVAILABLE Varianti disponibili	 45°  <05%-100%  Classic	 45°  <05%-100%  Smart Sky
	Classic	Smart Sky
POWER INPUT Power input	1 channel at 57 V 1050 mA cc	1 channels at 24 V DC
POWER CONSUMPTION Consumo energetico	60 W (Max) - 60 W (Typical)	60 W (Max) - 60 W (Typical)
TOTAL LIGHT OUTPUT Emissione luminosa	2010 lm	1810 lm (noon) - 1430 lm (sunset)
FRAME Cornice	The system can be surface recessed (trim or trimless) Il sistema può essere incassato a soffitto (trim o trimless)	
FRAME Cornice	Recessed trimless / Remote driver - on request	
ORDER CODE CERTIFICATION Codice di ordinazione Certificazione	SKYLINE-3L-A-01-CE CE, CB SKYLINE-3L-A-01-UL UL	Recessed trimless / Remote PSU - on request SKYLINE-SS-M-A-01-CE CE, CB ongoing SKYLINE-SS-S-A-01-UL UL ongoing SKYLINE-SS-M-A-01-CE CE, CB ongoing SKYLINE-SS-S-A-01-UL UL ongoing
	Recessed trim / Remote driver - on request	Recessed trim / Remote PSU - on request
	SKYLINE-3L-B-01-CE CE, CB SKYLINE-3L-B-01-UL UL	SKYLINE-SS-M-B-01-CE CE, CB ongoing SKYLINE-SS-S-B-01-UL UL ongoing SKYLINE-SS-M-B-01-CE CE, CB ongoing SKYLINE-SS-S-B-01-UL UL ongoing

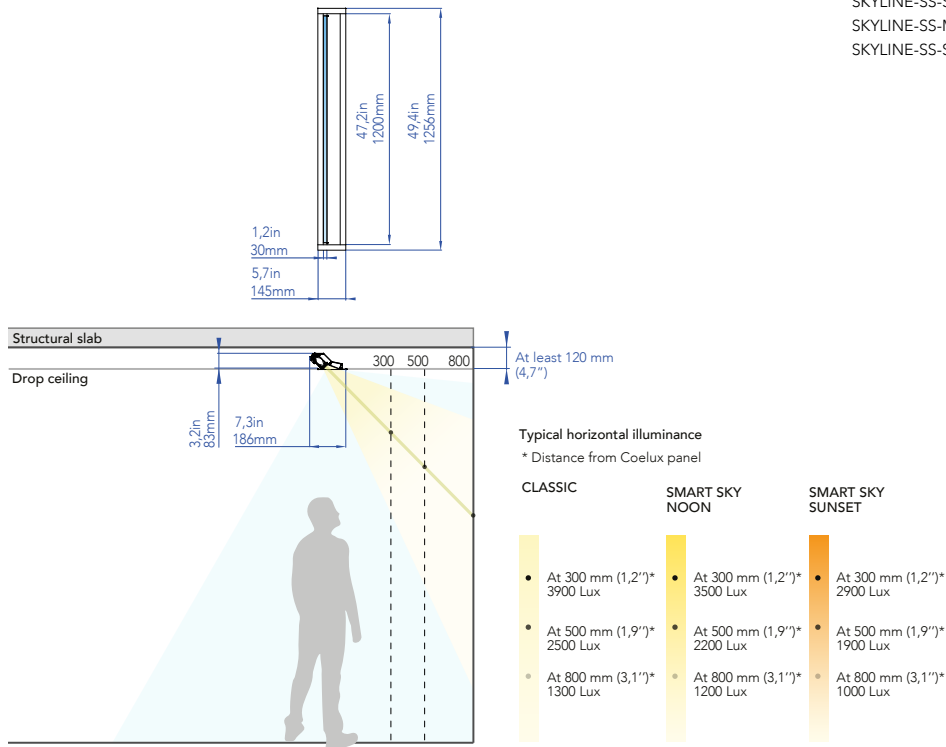

MOUNTING OPTIONS:

Recessed trim
Cornice incasso trim

Recessed trimless
Cornice incasso trimless



CoeLux LS

Long Sky



All the CoeLux LS systems can be dimmed from 0.1 to 100% to create daytime scenarios and a relaxing night-time atmosphere

Tutti i sistemi CoeLux LS sono dimmerabili dallo 0.1 al 100% per ricreare scenari diurni e una rilassante atmosfera notturna



CoeLux LS Ice

Light up your space

CoeLux LS Ice is the brightest window in the LS (Long sky) family. Fitted with an aluminium-finished frame reflecting the blue light of the sky and an intense light emitted by the CoeLux sun, it gives the viewer the perception of a larger portion of the sky, making the surrounding environment extremely bright.

CoeLux LS Ice è la più luminosa finestra della famiglia LS. Incorniciato da un frame dalla finitura in alluminio, sul quale si riflette la luce azzurra del cielo e un'intensa luce emessa dal sole CoeLux, regala all'osservatore la percezione di una porzione di cielo più grande, rendendo molto luminoso l'ambiente circostante.





CoeLux LS Ice

TECHNICAL INFORMATION:

SKYLIGHT SIZE Dimensione dello skylight	1086 x 295 mm 42.8 x 11.6"
WEIGHT Peso	30 kg 66 lb
NECESSARY SPACE FOR INSTALLATION* Dimensioni minime necessarie	1200 x 600 x 435 mm 47.2 x 23.6 x 17.1"

*dimensions may differ slightly depending on the versions

*le dimensioni possono differire leggermente a seconda delle varianti

VERSIONS AVAILABLE Varianti disponibili	 45°  0.1-100%	 45°  0.1-100%
	On board drivers - included	Remote drivers - on request
POWER INPUT Power input	100-240 V~ 50/60 Hz	4 channels, 450 mA each channel, 42 V DC
POWER CONSUMPTION Consumo energetico	100 W (Max) - 90 W (Typical)	80 W (Max) - 80 W (Typical)
TOTAL LIGHT OUTPUT Emissione luminosa	4300 lm	4300 lm
FRAME Cornice	Aluminium finish Finitura alluminio	Aluminium finish Finitura alluminio
ORDER CODE CERTIFICATION Codice di ordinazione Certificazione	LS-ICE-3L-DAL-UL UL, FCC LS-ICE-3L-010-UL UL, FCC LS-ICE-3L-DAL-BIS BIS	LS-ICE-3L-CE CE, CB, PSE LS-ICE-3L-CCC CCC LS-ICE-3L-KC KC

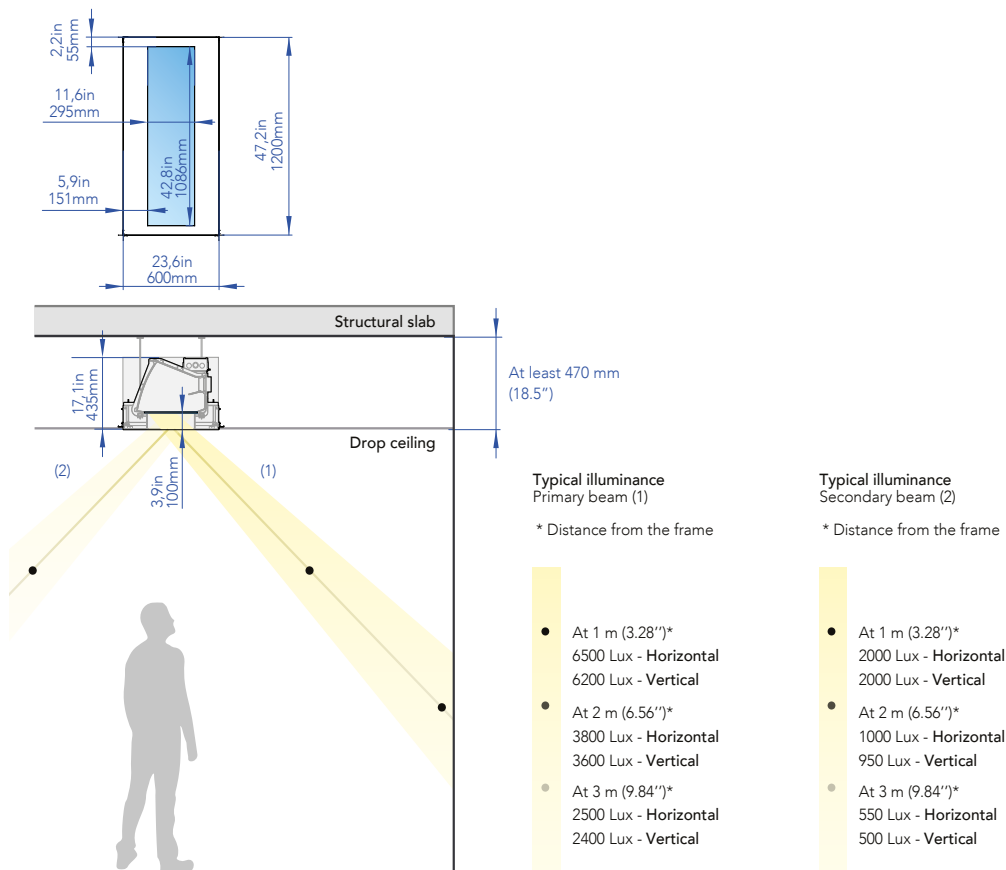



Coelux LS Ice





CoeLux LS Matte

Long sky, deep perception

Framing the sky, an elegant matt finish frame outlines the CoeLux LS Matte system. An elongated artificial window diffuses a beam of light at 45 degrees, creating a soft spot of light on the wall or in the surrounding environment.

Incorniciando il cielo, un'elegante finitura opaca delinea il sistema CoeLux LS Matte, una finestra artificiale dalla forma allungata che diffonde un fascio di luce a 45 gradi creando un morbido spot di luce sulla parete o nell'ambiente circostante.





CoeLux LS Matte

TECHNICAL INFORMATION:

SKYLIGHT SIZE Dimensione dello skylight	1086 x 295 mm 42.8 x 11.6"
WEIGHT Peso	30 kg 66 lb
NECESSARY SPACE FOR INSTALLATION* Dimensioni minime necessarie	1200 x 600 x 465 mm 47.2 x 23.6 x 18.3"

*dimensions may differ slightly depending on the versions

*le dimensioni possono differire leggermente a seconda delle varianti

VERSIONS AVAILABLE Varianti disponibili	 45°  0.1-100%	 45°  0.1-100%
	On board drivers - included	Remote drivers - on request
POWER INPUT Power input	100-240 V~ 50/60 Hz	4 channels, 450 mA each channel, 42 V DC
POWER CONSUMPTION Consumo energetico	100 W (Max) - 90 W (Typical)	80 W (Max) - 80 W (Typical)
TOTAL LIGHT OUTPUT Emissione luminosa	3300 lm	3300 lm
FRAME Cornice	White matte finish Finitura matte bianca	White matte finish Finitura matte bianca
ORDER CODE CERTIFICATION Codice di ordinazione Certificazione	LS-MATTE-3L-DAL-UL UL, FCC LS-MATTE-3L-010-UL UL, FCC LS-MATTE-3L-DAL-BIS BIS	LS-MATTE-3L-CE CE, CB, PSE LS-MATTE-3L-CCC CCC LS-MATTE-3L-KC KC

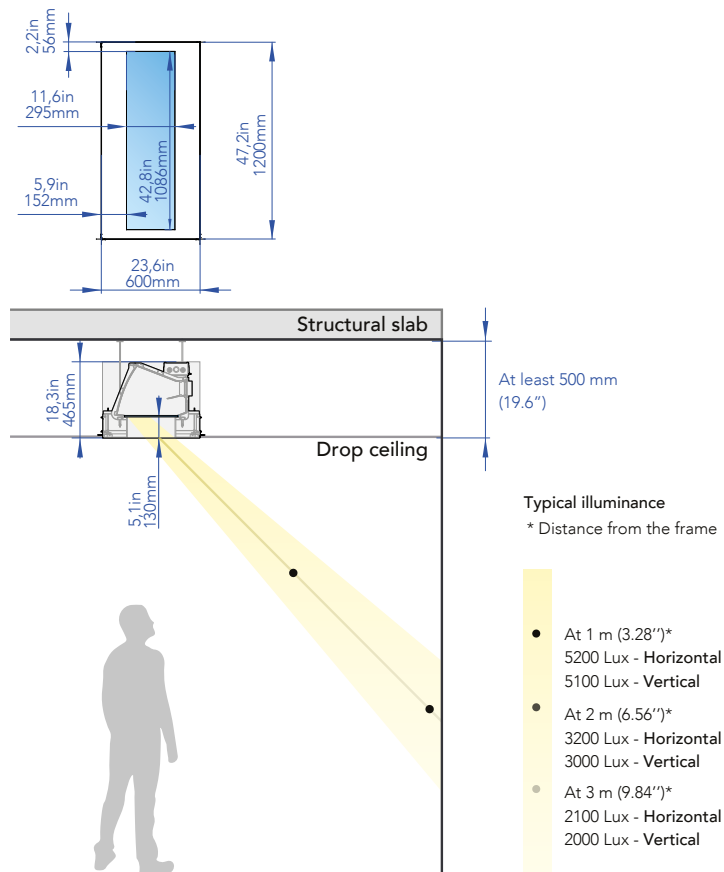



CoeLux LS Matte

CoeLux LS Matte, Qantas lounge,
Singapore Changi Airport, (SG)

coelux.com



CoeLux LS Array, Office space

Following the recommended guidelines, CoeLux LS Array can be installed either adjacent to the wall for a wall washing effect, or in other areas of the room.

Seguendo le linee guida consigliate, CoeLux LS Array è installabile sia adiacente alla parete per un effetto wall washing, sia in altre posizioni nella stanza.



CoeLux LS Array

The endless possibilities of the sky

The versatility of CoeLux LS Array allows you to create long corridors of sky. Each module is interrupted by a small geometric element that divides the window into two equal parts. The light projection on the wall, interspersed with small areas of shadow, gives the composition an extremely realistic effect.

La modularità infinita di CoeLux LS Array consente di creare lunghi corridoi di cielo. Ogni singolo modulo è interrotto da un piccolo elemento geometrico che divide la finestra in due parti uguali. Lo spot a parete, intervallato da piccole zone d'ombra, conferisce un effetto estremamente realistico alla composizione.

Coelux LS Array

TECHNICAL INFORMATION:

SKYLIGHT SIZE Dimensione dello skylight	498 x 295 mm (x2) 19.6 x 11.6" (x2)
WEIGHT Peso	24 kg 55 lb
NECESSARY SPACE FOR INSTALLATION* Dimensioni minime necessarie	1159 x 500 x 460 mm 45.6 x 19.7 x 18.1"

*dimensions may differ slightly depending on the versions

*le dimensioni possono differire leggermente a seconda delle varianti

VERSIONS AVAILABLE Varianti disponibili	45° 0.1-100%	45° 0.1-100%
	On board drivers - included	Remote drivers - on request
POWER INPUT Power input	100-240 V~ 50/60 Hz	4 channels, 450 mA each channel, 42 V DC
POWER CONSUMPTION Consumo energetico	100 W (Max) - 90 W (Typical)	80 W (Max) - 80 W (Typical)
TOTAL LIGHT OUTPUT Emissione luminosa	3000 lm	3000 lm
MODULES Modulo ORDER CODE CERTIFICATION Codice di ordinazione Certificazione	Head LS-ARR-HD-3L-DAL-UL UL, FCC LS-ARR-HD-3L-010-UL UL, FCC LS-ARR-HD-3L-DAL-BIS BIS	Head LS-ARR-HD-3L-DAL-CE CE, CB, PSE LS-ARR-HD-3L-DAL-CCC CCC LS-ARR-HD-3L-DAL-KC KC
MODULES Modulo ORDER CODE CERTIFICATION Codice di ordinazione Certificazione	Middle LS-ARR-MD-3L-DAL-UL UL, FCC LS-ARR-MD-3L-010-UL UL, FCC LS-ARR-MD-3L-DAL-BIS BIS	Middle LS-ARR-MD-3L-CE CE, CB, PSE LS-ARR-MD-3L-CCC CCC LS-ARR-MD-3L-KC KC
MODULES Modulo ORDER CODE CERTIFICATION Codice di ordinazione Certificazione	Single LS-ARR-SG-3L-DAL-UL UL, FCC LS-ARR-SG-3L-010-UL UL, FCC LS-ARR-SG-3L-DAL-BIS BIS	Single LS-ARR-SG-3L-CE CE, CB, PSE LS-ARR-SG-3L-CCC CCC LS-ARR-SG-3L-KC KC

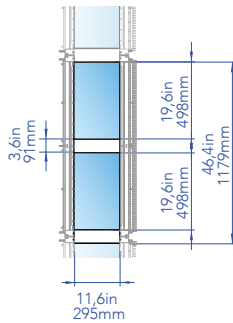

*Inspection hatch: required close to the projector.

*Botola di ispezione: necessaria vicino al proiettore.

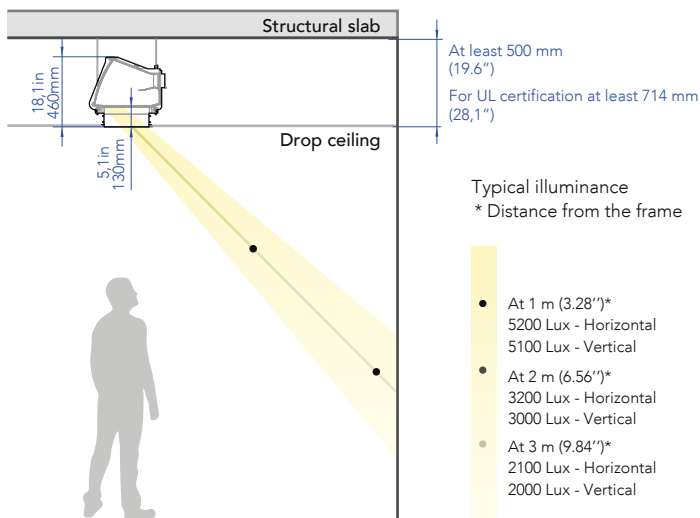

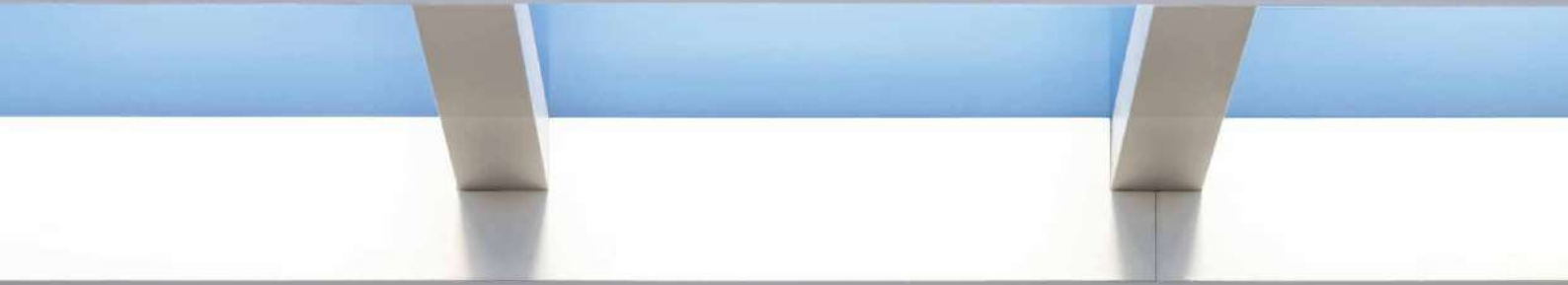

CoeLux LS Array, Office space

CoeLux LS Array

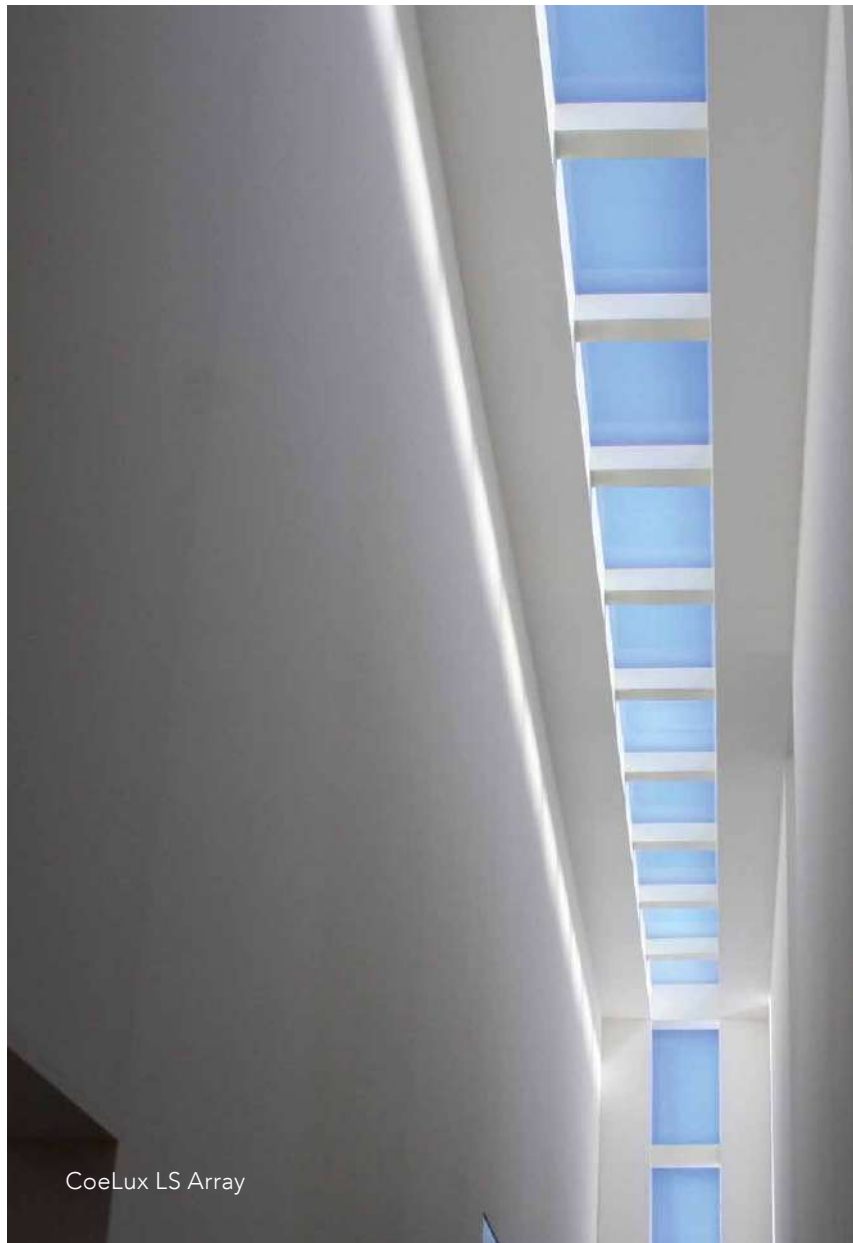

CoeLux LS Array can be positioned vertically to create scenic glimpses of sky.

CoeLux LS Array è posizionabile in verticale per creare scenografici spaccati di cielo.

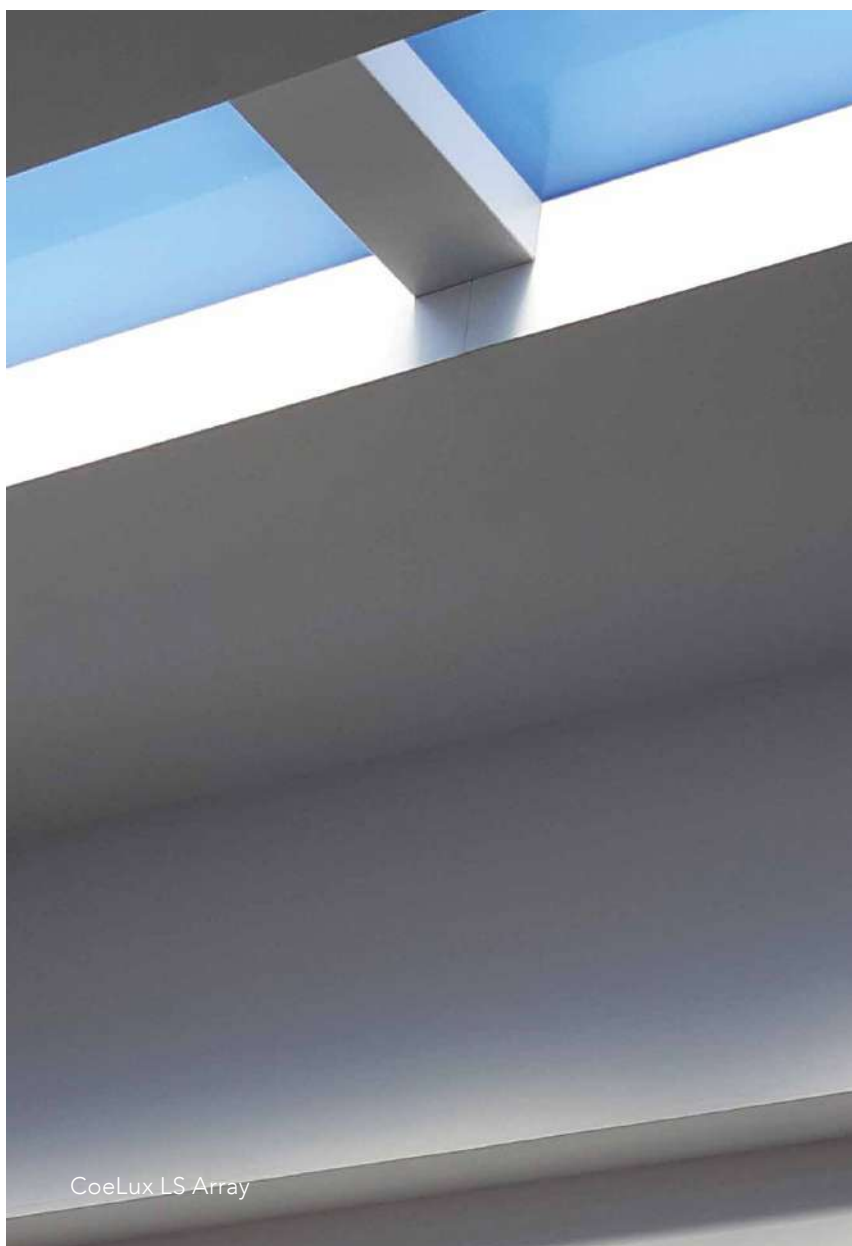

The frame spacing of CoeLux LS Array creates shadows and games of light.

L'intervallo della cornice di CoeLux LS Array crea ombre e giochi di luce.

CoeLux HE

High End



CoeLux 45 HC, NIKE Store, Milan (IT)

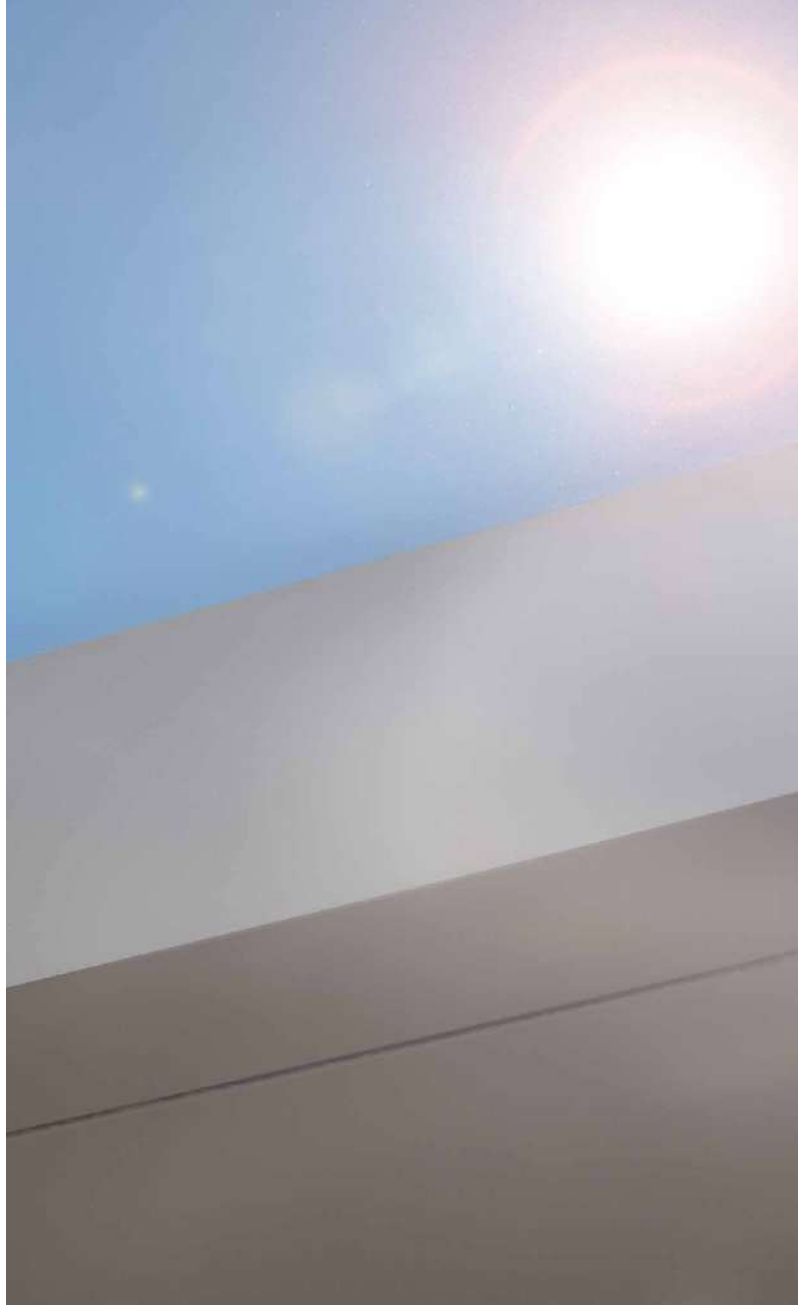

CoeLux 45 HC

Finally the sun indoors

The experience of the sky and the sun in contemporary architecture: CoeLux 45 HC is the largest of the CoeLux systems; a window of approximately 1.5 m² that can be installed on the ceiling, faithfully reproducing a blue sky and a bright sun.

L'esperienza del cielo e del sole nell'architettura contemporanea: CoeLux 45 HC è il più grande tra i sistemi CoeLux; una finestra di approssimativamente 1,5 m² installabile a soffitto, che riproduce fedelmente un cielo azzurro e un sole puntuale.







CoeLux 45HC

TECHNICAL INFORMATION:

SKYLIGHT SIZE Dimensione dello skylight	1710 x 850 mm 67.3 x 33.5"
WEIGHT* Peso	300 kg 660 lb
NECESSARY SPACE FOR INSTALLATION* Dimensioni minime necessarie	3759 x 2491 x 1210 mm 148 x 98.1 x 47.6"

*dimensions may differ slightly depending on the versions

*le dimensioni possono differire leggermente a seconda delle varianti

VERSIONS AVAILABLE Varianti disponibili	  45° Sun	  55-100% 45° Sun Plus	   55-100% 45° Sun Plus & Moon
POWER INPUT Power input	100-240 V~ 50/60 Hz	100-240 V~ 50/60 Hz	100-240 V~ 50/60 Hz
POWER CONSUMPTION Consumo energetico	300 W (Max) - 270 W (Typical)	300 W (Max) - 270 W (Typical)	300 W (Max) - 270 W (Typical)
TOTAL LIGHT OUTPUT Emissione luminosa	4100 lm	4700 lm	4700 lm - ~10 lm in a Moon state
FRAME Cornice	Recessed flushed	Recessed flushed	Recessed flushed
ORDER CODE CERTIFICATION Codice di ordinazione Certificazione	45HC_WD_CE CE, CB 45HC_WD_UL UL, FCC	45HC_WD_S_CE CE, CB, PSE 45HC_WD_S_UL UL, FCC	45HC_WD_S_M_CE CE, CB, PSE 45HC_WD_S_M_UL UL, FCC
FRAME Cornice	Ceiling mounted	Ceiling mounted	Ceiling mounted
ORDER CODE CERTIFICATION Codice di ordinazione Certificazione	45HC_PU_CE CE, CB 45HC_PU_UL UL, FCC	45HC_PU_S_CE CE, CB, PSE 45HC_PU_S_UL UL, FCC	45HC_PU_S_M_CE CE, CB, PSE 45HC_PU_S_M_UL UL, FCC

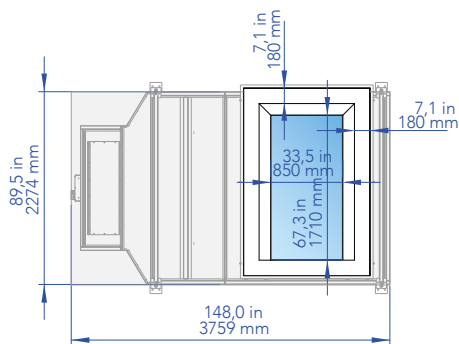

Inspection hatch: required close to the projector.

Botola di ispezione: necessaria vicino al proiettore.

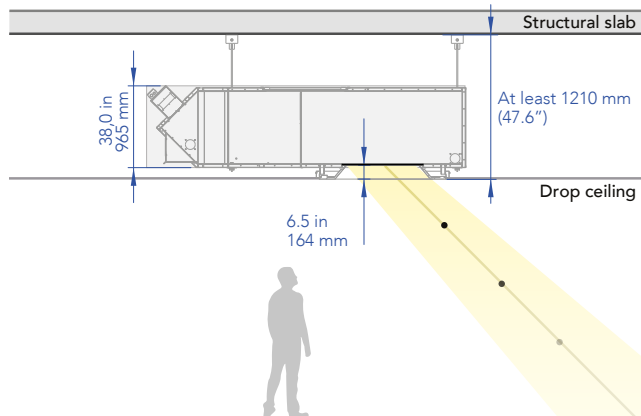

Typical horizontal illuminance

* Distance from CoeLux system (Sky)

Sun

- At 1 m (3.28")* 2000 Lux
- At 2 m (6.56")* 1300 Lux
- At 3 m (9.84")* 900 Lux

Sun Plus

- At 1 m (3.28")* 2300 Lux
- At 2 m (6.56")* 1500 Lux
- At 3 m (9.84")* 1000 Lux

FRAME TYPES:

Ceiling mounted
Cornice in rilievo

Recessed flushed
Cornice filo muro



CoeLux 45HC

Observe



The CoeLux 45 HC system is also available in the Sun & Moon version: a spectacular night-time scenario that reconnects us with the first celestial object we can see clearly with the naked eye: the moon.

Il sistema CoeLux 45 HC è disponibile anche nella versione Sun & Moon: uno scenografico scenario notturno per riconnettersi al primo oggetto celeste che l'uomo è in grado di vedere con chiarezza a occhio nudo: la luna.

Explore



Coelux 45HC



Ceiling Mounted frame,
protruding slightly from
the false ceiling

Frame Ceiling Mounted,
leggermente sporgente
rispetto al controsoffitto



CoeLux 45 HC, Boffi S.p.a., Milan (IT)



CoeLux 45 HC, Gorlini Showroom, Milan (IT)

Frame Recessed flushed,
installed in line with the
false ceiling

Frame *Recessed flushed*,
installato a filo del
controsoffitto



With proper positioning,
more than one HE system
can be installed within
the same space, creating
spectacular
games of light

Grazie ad un corretto
posizionamento, è possibile
installare più di un sistema
HE all'interno dello stesso
spazio, creando spettacolari
giochi di luce



CoeLux 45 LC

To be but not too big

The perfection of the CoeLux sun in the smallest skylight of the HE family. The reproduction of natural light and the visual appearance of the sky and the sun, typical of the HE family, are reduced in the size of the system, perfect in any medium-height architectural context.

La perfezione del sole CoeLux nella finestra più piccola della famiglia HE. La riproduzione della luce naturale e la visual appearance del cielo e del sole, vengono concentrate nelle dimensioni del sistema, ideale in contesti architettonici che dispongono di medie altezze.







CoeLux 45LC

TECHNICAL INFORMATION:

SKYLIGHT SIZE Dimensione dello skylight	960 x 460 mm 37.8 x 18.1"
WEIGHT* Peso	300 kg 660 lb
NECESSARY SPACE FOR INSTALLATION* Dimensioni minime necessarie	2376 x 1913 x 923 mm 93.6 x 75.3 x 36.3"

*dimensions may differ slightly depending on the versions

*le dimensioni possono differire leggermente a seconda delle varianti

	  45°	  55-100% 45°	   55-100% 45°
VERSIONS AVAILABLE Varianti disponibili	Sun	Sun Plus	Sun Plus & Moon
POWER INPUT Power input	100-240 V~ 50/60 Hz	100-240 V~ 50/60 Hz	100-240 V~ 50/60 Hz
POWER CONSUMPTION Consumo energetico	300 W (Max) - 270 W (Typical)	300 W (Max) - 270 W (Typical)	300 W (Max) - 270 W (Typical)
TOTAL LIGHT OUTPUT Emissione luminosa	4200 lm	4800 lm	4800 lm - ~10 lm in a Moon state
FRAME Cornice ORDER CODE CERTIFICATION Codice di ordinazione Certificazione	Recessed flushed 45LC_WD_CE CE, CB 45LC_WD_UL UL, FCC	Recessed flushed 45LC_WD_S_CE CE, CB, PSE 45LC_WD_S_UL UL, FCC	Recessed flushed 45LC_WD_S_M_CE CE, CB, PSE 45LC_WD_S_M_UL UL, FCC
FRAME Cornice ORDER CODE CERTIFICATION Codice di ordinazione Certificazione	Ceiling mounted 45LC_PU_CE CE, CB 45LC_PU_UL UL, FCC	Ceiling mounted 45LC_PU_S_CE CE, CB, PSE 45LC_PU_S_UL UL, FCC	Ceiling mounted 45LC_PU_S_M_CE CE, CB, PSE 45LC_PU_S_M_UL UL, FCC
FRAME Cornice ORDER CODE CERTIFICATION Codice di ordinazione Certificazione	9cm 45LC_9CM_CE CE, CB 45LC_9CM_UL UL, FCC	9cm 45LC_9CM_S_CE CE, CB, PSE 45LC_9CM_S_UL UL, FCC	9cm 45LC_9CM_S_M_CE CE, CB, PSE 45LC_9CM_S_M_UL UL, FCC

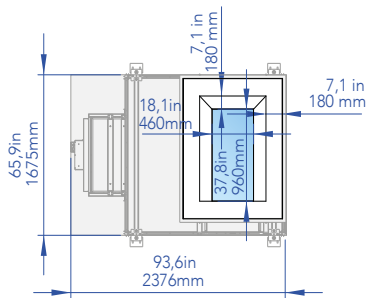

Inspection hatch: required close to the projector.

Botola di ispezione: necessaria vicino al proiettore.

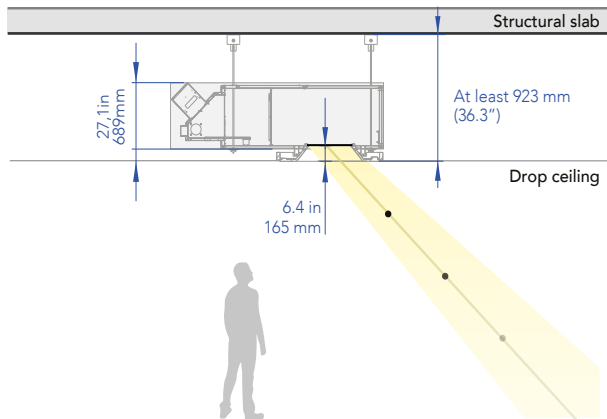

Typical horizontal illuminance

* Distance from CoeLux system (Sky)

Sun

- At 1 m (3.28")* 4600 Lux
- At 2 m (6.56")* 2600 Lux
- At 3 m (9.84")* 1600 Lux

Sun Plus

- At 1 m (3.28")* 5000 Lux
- At 2 m (6.56")* 2900 Lux
- At 3 m (9.84")* 1800 Lux

FRAME TYPES:

Ceiling mounted
Cornice in rilievo

Recessed flushed
Cornice filo muro

9cm





CoeLux 45 LC

CoeLux 45 LC, BCG Group, Milan (IT)

CoeLux 45 LC

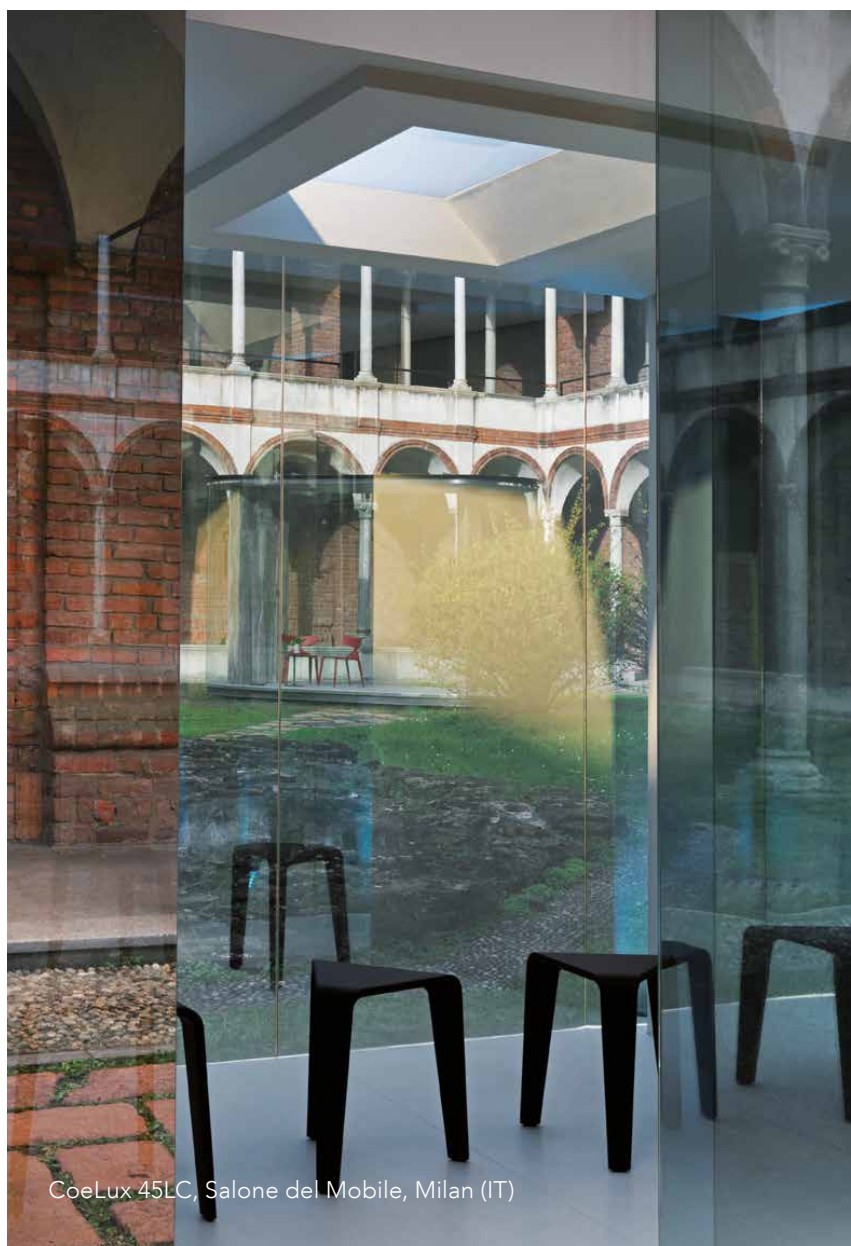

Ceiling Mounted frame,
protruding slightly from the
false ceiling

Frame Ceiling Mounted,
leggermente sporgente
rispetto al controsoffitto



Frame Recessed flushed,
installed flush with the
false ceiling

Frame Recessed flushed,
installato a filo del
controsoffitto



Thanks to the sophisticated
optical system, the craters and the
morphology of the moon appear
remarkably realistic

Grazie al sofisticato sistema di ottiche
all'interno del sistema, i crateri e la
morfologia della luna appaiono in
maniera estremamente realistica





Designed for spaces without high ceilings, CoeLux 45 Square recreates, through a game of mirrors, a perceived square window measuring about one square metre

Ideale per spazi che non dispongono di grandi altezze, CoeLux 45 Square ricrea attraverso un gioco di specchi una finestra percepita quadrata, della dimensione di circa un 1 mq.



CoeLux 45 Square

The geometry of the sky

The sensation of depth perceived by the viewer is amplified by the geometry of the system: the sharp, bright sun is reflected in the mirror placed on the ceiling and through an elaborate system of optics.





La sensazione di profondità percepita dall'osservatore viene amplificata dalla geometria del sistema: nello specchio disposto sul soffitto e attraverso un elaborato sistema di ottiche, viene riflesso il sole, puntuale e luminoso.

CoeLux 45 Square

TECHNICAL INFORMATION:

SKYLIGHT SIZE Dimensione dello skylight	974 x 445 mm 38.3 x 17.5"
WEIGHT* Peso	300 kg 660 lb
NECESSARY SPACE FOR INSTALLATION* Dimensioni minime necessarie	1885 x 1656 x 2376 mm 74.2 x 65.2 x 93.6"

*dimensions may differ slightly depending on the versions
*le dimensioni possono differire leggermente a seconda delle varianti

VERSIONS AVAILABLE Varianti disponibili	  45°	  55-100% 45°
	Sun	Sun Plus
POWER INPUT Power input	100-240 V~ 50/60 Hz	100-240 V~ 50/60 Hz
POWER CONSUMPTION Consumo energetico	300 W (Max) - 270 W (Typical)	300 W (Max) - 270 W (Typical)
TOTAL LIGHT OUTPUT Emissione luminosa	4000 lm	4500 lm
ORDER CODE CERTIFICATION Codice di ordinazione Certificazione	45SQ_WD_CE CE, CB 45SQ_WD_UL UL, FCC	45SQ_WD_S_CE CE, CB, PSE 45SQ_WD_S_UL UL, FCC

Inspection hatch: required close to the projector.

Botola di ispezione: necessaria vicino al proiettore.

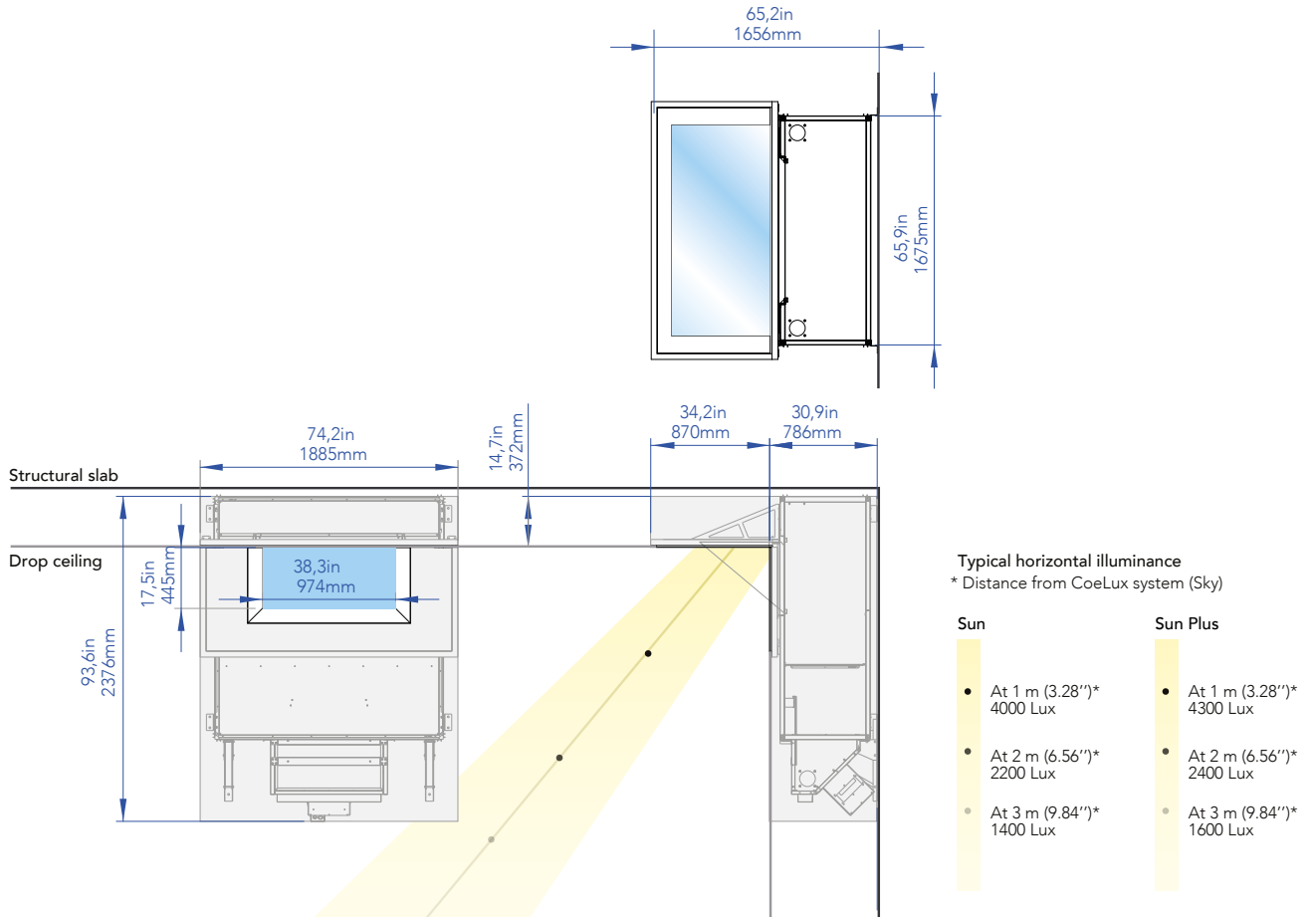

CoeLux 45 Square





For commercial information, please contact us at:

Italy only: sales.italia@coelux.com

Worldwide (excluding Italy): sales@coelux.com

PHOTOS
Michael Loos
DSL Studio
Nava-Rapacchieta photography
Marco Cappelletti photography

pixabay.com

© Copyright 2019

The products presented herein are covered by patents and patent applications. Details available at <https://www.coelux.com/en/patents/index>

CoeLux reserves the right to modify the technical characteristics of the models illustrated in this catalogue without prior notice. Copying any part of this catalogue is strictly forbidden.

I prodotti qui presentati sono brevettati e coperti da domande di brevetto. Dettagli disponibili su <https://www.coelux.com/en/patents/index>

CoeLux si riserva il diritto di modificare, senza alcun preavviso le caratteristiche tecniche dei modelli illustrati nel presente catalogo. Vietata la riproduzione parziale o totale del presente catalogo.

CAT-92022-01

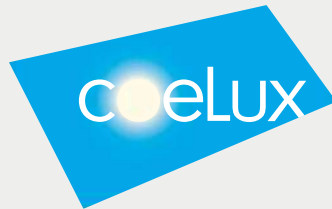

Experience the Sky

CoeLux Srl

Via Cavour 2 / Science and Technology
Park ComoNExT
22074, Lomazzo, Italy
info@coelux.com - +39 0236714394

coelux.com